

**AD-630**  
**DUAL MICROPROCESSOR CONTROL (DMC)**  
**GAS**  
(for models mfd. as of June 1993)  
**INSTALLATION MANUAL**

**WARNING:** For your safety the information in this manual must be followed to minimize the risk of fire or explosion or to prevent property damage, personal injury or loss of life.

Do not store or use gasoline or other flammable vapors and liquids in the vicinity of this or any other appliance.

**WHAT TO DO IF YOU SMELL GAS**

- Do not try to light any appliance.
- Do not touch any electrical switch; do not use any phone in your building.
- Clear the room, building or area of all occupants.
- Immediately call your gas supplier from a neighbor's phone. Follow the gas supplier's instructions.
- If you cannot reach your gas supplier, call the fire department.

Installation and service must be performed by a qualified installer, service agency or the gas supplier.



For replacement parts, contact the distributor from which the dryer was purchased or

American Dryer Corporation

88 Currant Road Fall River, MA 02720-4781

Telephone: (508) 678-9010 / Cable: AMDRY

## **Retain This Manual In A Safe Place For Future Reference**

American Dryer Corporation products embody advanced concepts in engineering, design, and safety. If this product is properly maintained, it will provide many years of safe, efficient, and trouble-free operation.

**ONLY** properly licensed technicians should service this equipment.

Observe all safety precautions displayed on the equipment or specified in the installation/operator's manual included with the dryer.

Under **NO circumstances should the dryer door switch or the heat circuit devices ever be disabled.**

We have tried to make this manual as complete as possible and hope you will find it useful. ADC reserves the right to make changes from time to time, without notice or obligation, in prices, specifications, colors, and materials and to change or discontinue models.

### **Important**

For your convenience, log the following information:

DATE OF PURCHASE \_\_\_\_\_ MODEL NO. AD-630

DISTRIBUTOR'S NAME \_\_\_\_\_

Serial No.(s) \_\_\_\_\_

Replacement parts can be ordered from your distributor or the ADC factory. When ordering replacement parts from the factory, you can fax your order to ADC at (508) 678-9447 or telephone your orders directly to the ADC Parts Department at (508) 678-9010. Please specify the dryer model number and serial number in addition to the description and part number, so that your order is processed accurately and promptly.

The illustrations on the following pages may not depict your particular dryer exactly. The illustrations are a composite of the various dryer models. Be sure to check the descriptions of the parts thoroughly before ordering.

**INSTRUCTIONS TO BE FOLLOWED IN THE  
EVENT THE USER SMELLS GAS MUST BE POSTED  
IN A PROMINENT LOCATION. THE INSTRUCTIONS  
TO BE POSTED SHALL BE OBTAINED FROM THE  
LOCAL GAS SUPPLIER.**

## **FOR YOUR SAFETY**

DO NOT STORE OR USE GASOLINE OR OTHER FLAMMABLE VAPORS AND LIQUIDS IN THE VICINITY OF THIS OR ANY OTHER APPLIANCE.

DO NOT DRY MOP HEADS IN THE DRYER.

DO NOT USE DRYER IN THE PRESENCE OF DRY CLEANING FUMES.

## **WARNING**

CHILDREN SHOULD NOT BE ALLOWED TO PLAY ON OR IN THE DRYER(S).

CHILDREN SHOULD BE SUPERVISED IF NEAR DRYER(S) IN OPERATION.

## **CAUTION**

DRYER(S) SHOULD NEVER BE LEFT UNATTENDED WHILE IN OPERATION.

## **IMPORTANT**

Please observe all safety precautions displayed on the equipment and/or specified in the installation/operators manual included with the dryer.

Dryer(s) must not be installed or stored in an area where it will be exposed to water and/or weather.

The wiring diagram for the dryer is located in the front electrical control box area.

# Table of Contents

<b>SECTION I</b>	
<b>IMPORTANT INFORMATION</b> .....	2
A. Receiving and Handling .....	2
B. Safety Precautions .....	3
<b>SECTION II</b>	
<b>SPECIFICATIONS</b> .....	6
<b>SECTION III</b>	
<b>INSTALLATION PROCEDURES</b> .....	8
A. Unpacking / Setup .....	8
B. Location of Dryer .....	9
C. Dryer Enclosure Requirements .....	9
D. Fresh Air Supply .....	11
E. Exhaust Requirements .....	12
F. Electrical Information .....	28
G. Gas Information .....	31
H. Preparation For Operation .....	37
I. Preoperational Tests .....	37
<b>SECTION IV</b>	
<b>OPERATING INSTRUCTIONS</b> .....	42
A. Starting The Dryer .....	42
B. Shut Down Instructions .....	45
<b>Section V</b>	
<b>SERVICE / PARTS INFORMATION</b> .....	46
A. Service .....	46
B. Parts .....	46
<b>SECTION VI</b>	
<b>WARRANTY INFORMATION</b> .....	47
A. Returning Warranty Card(s) .....	47
B. Warranty .....	47
C. Returning Warranty Parts .....	48
<b>SECTION VII</b>	
<b>ROUTINE MAINTENANCE</b> .....	50
A. Cleaning .....	50
B. Adjustments .....	52
C. Lubrication .....	52
<b>SECTION VIII</b>	
<b>TROUBLESHOOTING</b> .....	53
<b>SECTION IX</b>	
<b>DATA LABEL LOCATION / INFORMATION</b> .....	63

# SECTION I

## IMPORTANT INFORMATION

### A. Receiving and Handling

The dryer is shipped in a protective stretch wrap cover with protective cardboard corners and top cover (or optional box) as a means of preventing damage in transit. Upon delivery, the dryer and/or protective packaging, and wooden skid **should be** visually inspected for shipping damage. If any damage whatsoever is noticed, inspect further before delivering carrier leaves.

#### Dryers Damaged in Shipment:

1. **ALL** dryers **should be** inspected upon receipt and before they are signed for.
2. If there is suspected damage or actual damage, the trucker's receipt **should be** so noted.
3. If the dryer is damaged beyond repair, it **should be** refused. Those dryers which were not damaged in a damaged shipment **should be** accepted, but the number received and number refused **must be** noted on the receipt.
4. If you determine that the dryer was damaged after the trucker has left your location, you should call the delivering carrier's freight terminal immediately and file a claim. This type of freight claim is very difficult to get paid and becomes extremely difficult when more than a day or two passes after the freight was delivered. It is your responsibility to file freight claims. Dryers/parts damaged in transit **cannot** be claimed under warranty.
5. Freight claims are the responsibility of the consignee, and all claims **must be** filed at the receiving end. ADC assumes no responsibility for freight claims or damages.
6. If you need assistance in handling the situation, please call ADC's Traffic Manager at (508) 678-9000.

**IMPORTANT:** The dryer **must be transported and handled in an upright position at all times.**

## **B. Safety Precautions**

**WARNING:** For your safety, the information in this manual **must be followed to minimize the risk of fire or explosion or to prevent property damage, personal injury, or loss of life.**

1. **DO NOT** store or use gasoline or other flammable vapors and liquids in the vicinity of this or any other appliance.
2. Purchaser/user should consult the local gas supplier for proper instructions to be followed in the event the user smells gas. The instructions **should be posted** in a prominent location.
3. WHAT TO DO IF YOU SMELL GAS:
  - A) **DO NOT** try to light any appliance.
  - B) **DO NOT** touch any electrical switch.
  - C) **DO NOT** use any phone in your building.
  - D) Clear the room, building, or area of all occupants.
  - E) Immediately call your gas supplier from a neighbor's telephone. Follow the gas supplier's instructions.
  - F) If you can not reach your gas supplier, call the fire department.
4. Installation and service **must be performed** by a qualified installer, service agency, or the gas supplier.
5. Dryer(s) **must be exhausted** to the outdoors.
6. Although ADC produces a very versatile machine, there are some articles that, due to fabric composition or cleaning method, **should not be dried** in it.

**WARNING:** Dry only water-washed fabrics. **DO NOT** dry articles spotted or washed in dry cleaning solvents, a combustible detergent, or "all purpose" cleaner. **EXPLOSION COULD RESULT.**

**WARNING:** **DO NOT** dry rags or articles coated or contaminated with gasoline, kerosene, oil, paint, or wax. **EXPLOSION COULD RESULT.**

**WARNING:** **DO NOT** DRY MOP HEADS. Contamination by wax or flammable solvents will create a fire hazard.

**WARNING:** **DO NOT** use heat for drying articles that contain plastic, foam, sponge rubber, or similarly textured rubber-like materials. Drying in a heated basket (tumbler) may damage plastics or rubber and also may be a fire hazard.

7. A program should be established for the inspection and cleaning of lint in the burner area, exhaust duct work and area around the back of the dryer. The frequency of inspection and cleaning can best be determined from experience at each location.

**WARNING: THE COLLECTION OF LINT IN THE BURNER AREA and EXHAUST DUCT WORK CAN CREATE A POTENTIAL FIRE HAZARD.**

8. For personal safety, the dryer must be electrically grounded in accordance with local codes and/or the National Electric Code ANSI/NFPA NO. 70-LATEST EDITION, or in CANADA, the Canadian Electrical Codes Parts 1 & 2 CSA C22.1-1990 or LATEST EDITION.

**NOTE:** Failure to do so will **VOID THE WARRANTY.**

9. **UNDER NO CIRCUMSTANCES** should the dryer door switch, lint basket (drawer) switch, or heat circuit safety devices ever be disabled.

**WARNING: PERSONAL INJURY or FIRE COULD RESULT.**

10. This dryer is not to be used in the presence of dry cleaning solvents or fumes.
11. Remove articles from the dryer as soon as the drying cycle has been completed.

**WARNING: Articles left in the dryer after the drying and cooling cycles have been completed can create a fire hazard.**

12. READ and FOLLOW **ALL** CAUTION and DIRECTION LABELS ATTACHED TO THE DRYER.



# SECTION II

## AD-630 SPECIFICATIONS

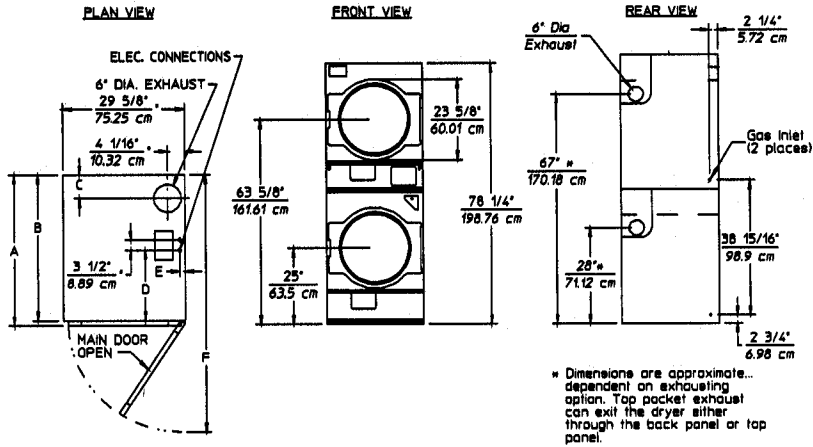

AD-630		
A	44"	111.76 cm
B	42-3/4"	108.56 cm
C	5-5/8"	14.29 cm
D	16-11/16"	42.39 cm
E	1-3/16"	3.02 cm
F	71-1/2"	181.61 cm

Shaded areas are in metric equivalents.

MAN1259

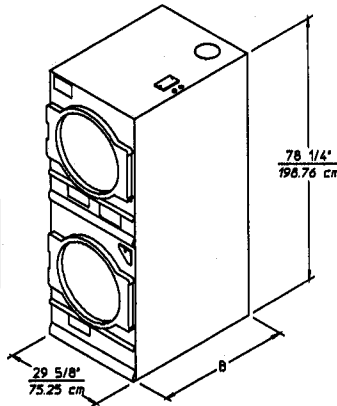

**NOTE:** ADC reserves the right to make changes in specifications at any time, without notice or obligation.

## AD-630 Specifications

Maximum Capacity (dry weight)*	60 lbs.	27.2 kg
Basket (tumbler) Diameter	27-1/4"	69.22 cm
Basket (tumbler) Depth	30"	76.2 cm
Basket (tumbler) Volume (per basket)	10.1 cu.ft.	286 cu.m.
Basket (tumbler) Motor (2 places)	1.5 HP	1.12 kw
Door Opening - Diameter (2 places)	21-1/2"	54.61 cm
Exhaust Duct Outlet (2 places)	6"	15.24 cm
Voltage Available	115-240v / 1ø / 50/60Hz	
Approx. Weight (uncrated)	800 lbs.	363.2 kg
Approx. Weight (crated)	830 lbs.	376.5 kg
Heat Input (total for both baskets)	245,000 btu/hr	61,740 kcal/hr
Airflow (per basket/tumbler)	825 cfm	23.3 cmm
Gas Inlet Size (2 places)	3/4"	1.91 cm

*Shaded areas are in metric equivalents.*

\* Total capacity for both baskets (tumblers).

\*\* **EXHAUST MUST BE INCREASED TO A MINIMUM OF 8-INCH DIAMETER IMMEDIATELY AFTER LEAVING THE DRYER CABINET.**

**NOTE:** ADC reserves the right to make changes in specifications at any time, without notice or obligation.

# SECTION III

## INSTALLATION PROCEDURES

Installation should be performed by qualified professionals in accordance with local and state codes. In the absence of these codes, installation must conform to applicable AMERICAN NATIONAL STANDARDS:

ANSI Z223.1 - LATEST EDITION (NATIONAL FUEL CODE)

or

ANSI/NFPA No. 70 - LATEST EDITION (NATIONAL ELECTRIC CODE)

or in CANADA, the installation must conform to applicable CANADIAN STANDARDS:

CAN/CGA-B149.1-M91 (Natural Gas) or CAN/CGA-B149.2-M91 (L.P. GAS) or LATEST EDITION (for GENERAL INSTALLATION and GAS PLUMBING)

or

CANADIAN ELECTRICAL CODES PARTS 1 & 2 CSA C22.1-1990 or LATEST EDITION (for ELECTRICAL CONNECTIONS).

### A. Unpacking/Setup

Remove stretch wrap protective cover, shipping corners, and top cover from dryer.

**NOTE:** The access keys for the service doors are included in the information packet shipped in the basket (tumbler). These keys should be removed and put in a safe place yet made accessible because some will be needed throughout various phases in the installation of the dryer.

Coin dryers are shipped with a coin box and coin box faceplate only. The coin box lock **is not** included and **must be** purchased elsewhere or the lock can be ordered as a parts order from the ADC factory.

The dryer can be moved to its final location while still attached to the skid or with the skid removed. To unskid the dryer, locate and remove the four (4) bolts securing the base of the dryer to the wooden skid. Two (2) are located at the rear of the base, and two (2) are located in the front. Once the bolts are removed, slide the dryer off the skid.

With the skid removed, to make it easier to slide the dryer into its final position, slightly lower **ALL** leveling legs so that the dryer will slide on the legs instead of the base frame. The dryer is equipped with four (4) leveling legs, one at each corner of the dryer base. The hex head adjustment bolts for the two (2) front leveling legs are located directly behind the lower access door, and the rear two (2) adjustments are directly behind the lower rear back (guard) panel.

## B. Location Of The Dryer

Before installing the dryer, be sure the location conforms to local codes and ordinances.

The dryer **must** be installed on a sound, level floor capable of supporting its weight. It is recommended that carpeting be removed from the floor area on which the dryer is to rest.

Even though a 12-inch clearance is acceptable, it is recommended that the rear of the dryer be positioned approximately 2 feet away from the nearest obstruction, i.e. wall, for ease of installation, maintenance, and service.

## C. Dryer Enclosure Requirements

Bulkheads and partitions **should** be made of noncombustible materials and **must** be located a minimum of 6-inches above the dryer outer top, except along the front of the dryer which may be closed in if desired.

**NOTE:** Even though a minimum of 6-inches above the dryer outer top is acceptable, a clearance of 18-inches (or more) is suggested for ease of installation and service (power electrical connections).

**NOTE:** When fire sprinkler systems are located above the dryers, a minimum of 12-inches above the dryer outer top is required.

CLEARANCES SHOWN ARE MINIMUM DIMENSIONS TO NEAREST COMBUSTIBLE MATERIALS.

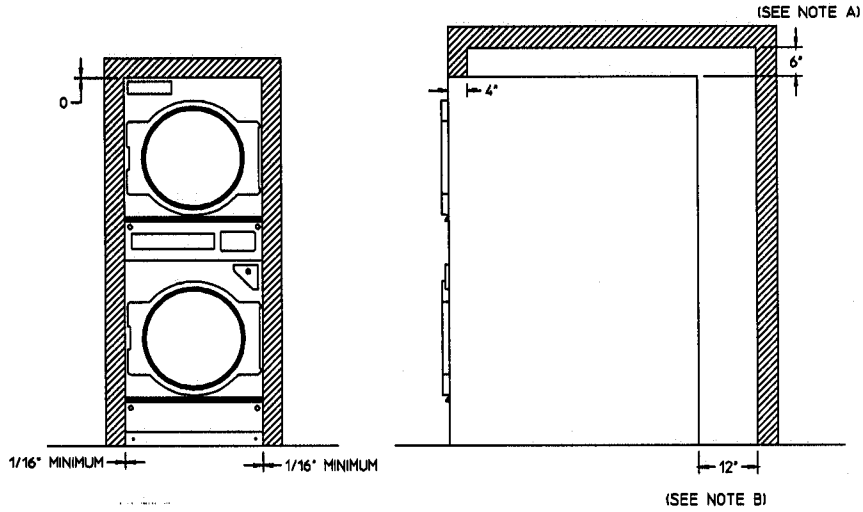

**NOTES:**

- A. MINIMUM OF 6" CLEARANCE IS ACCEPTABLE FOR EASE OF INSTALLATION and SERVICE (POWER CONNECTIONS). AT LEAST 18" IS RECOMMENDED.
- B. MINIMUM OF 12" CLEARANCE IS ACCEPTABLE FOR EASE OF INSTALLATION, MAINTENANCE, and SERVICE. AT LEAST 24" IS RECOMMENDED.

MAN0340

## D. Fresh Air Supply

Air supply (make-up air) **must be given careful consideration** to assure proper and safe performance of each dryer. An unrestricted source of air of 825 cfm is necessary for each tumbler. An unrestricted air entrance from the outdoors (atmosphere) of a minimum of 3 square feet is required for each dryer. This area **must be enlarged** if louvers or registers cover the opening. It is not necessary to have a separate make-up air opening for each dryer. Common make-up air openings are acceptable. However, they **must be set up** in such a manner that the make-up air is distributed equally to the dryers. For example, for a bank of eight (8) dryers, a total make-up air opening of 24 square feet is required. Two (2) openings measuring 3' by 4' (12 square feet) are acceptable.

Allowances **must be made** for remote or constricting passageways or where dryers are located at excessive altitudes or predominantly low pressure areas.

**IMPORTANT:** Make-up air **must be provided** from a source free of dry cleaning solvent fumes. Make-up air contaminated by dry cleaning solvents will result in irreparable damage to motors and dryer components.

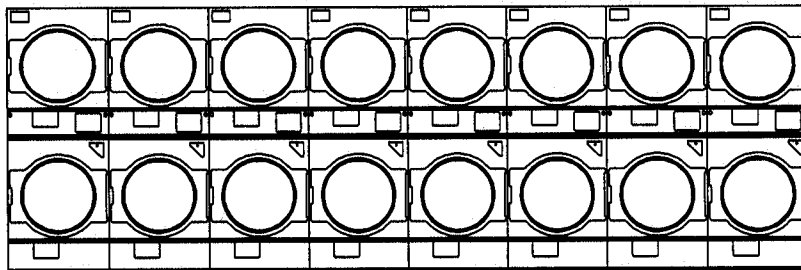

MAN1647

TYPICAL INSTALLATION SHOWING MAKE-UP AIR OPENINGS

**IMPORTANT:** Make-up air openings **SHOULD NOT** be located near duct work exhaust outlets. If make-up air opening (s) are too close to the exhaust outlet, lint and fumes may be drawn back into the dryer area through these openings.

**NOTE:** Component failure due to dry cleaning solvent fumes **VOIDS THE WARRANTY.**

## **E. Exhaust Requirements**

### **General Information**

Exhaust duct work **should be** designed and installed by a competent technician. Improperly sized duct work will create excessive back pressure which results in slow drying, increased use of energy, and shut-down of the burner by the airflow (sail) switch, burner hi-limit, or lint chamber hi-heat protector thermostat.

Where possible, it is suggested that a separate (single) exhaust duct for each dryer/tumbler be provided.

**CAUTION: IMPROPERLY SIZED or INSTALLED EXHAUST DUCT WORK CAN CREATE A POTENTIAL FIRE HAZARD.**

**CAUTION: DRYER MUST BE VENTED TO THE OUTDOORS.**

The exhaust duct work **should be** laid out in such a way that the duct travels as directly as possible to the outdoors with as few turns as possible. The shape of the duct work is not critical so long as the minimum cross-sectional area is provided.

It is suggested that the use of 90° turns in ducting be avoided; use 30° or 45° angles instead.

The duct work **should be** smooth inside with no projections from sheet metal screws or other obstructions which will collect lint. When adding

ducts, the ducts to be added should overlap the duct to which it is connected. **ALL** duct work joints **must be** taped to prevent moisture and lint from escaping into the building. Additionally, inspection doors **should be** installed at strategic points in the exhaust duct work for periodic inspection and cleaning.

The duct work material used **must meet** applicable National, State, and Local codes, or in CANADA, the duct work material used **must meet** applicable Canadian National, Provincial, and Local codes.

**IMPORTANT:** When connecting duct work to the dryer's top basket (tumbler) exhaust duct work, be sure that when screws are used they **do not** restrict the operation (both opening and closing) of the damper.

**NOTE:** When the exhaust duct passes through a wall, ceiling, or roof made of combustible materials, the opening **must be** 2-inches larger (all the way around) than the duct. The duct **must be** centered within this opening.

To protect the outside end of the horizontal duct work from the weather, a 90° elbow bent downward **should be** installed where the exhaust exits the building. If the exhaust duct work travels vertically up through a roof, it **should be** protected from the weather by using a 180° turn to point the opening downward. In either case, allow at least twice the diameter of the duct between the duct opening and the nearest obstruction (i.e. roof or ground level).

**IMPORTANT:** **DO NOT** use screens or caps on the outside opening of the exhaust duct work.

**IMPORTANT:** Exhaust back pressure measured by a manometer at the dryer exhaust duct area **must not** exceed 0.3 inches of water column.

**NOTE:** Careful consideration **should be** given to where the exhaust duct is located in relation to the make up air openings. If make up air opening is too close to exhaust outlet, lint and fumes will be drawn back in to the dryer area through these openings.



If the length of duct work run or quantity of elbows used exceeds the specifications noted in this booklet, the cross section area of the duct work **must** be increased in proportion to the number of elbows or duct run added.

**IMPORTANT:** For extended duct work runs, the cross section area of the duct can only be increased to an extent. For extended duct work runs, a professional HVAC firm **should** be consulted for proper venting information.

Duct work **should** be laid out in such a manner where allowances are made at the rear of the dryer for removal of rear service panels/guards.

**IMPORTANT:** Even though the dryer's exhaust outlet size is six (6) inches in diameter (at both the top basket [tumbler] damper duct and the bottom basket [tumbler] elbow where it leaves the dryer), the **minimum connection at the point of exit from the dryer in ALL cases MUST BE increased.** The amount of increase in diameter will depend on the venting application/layout as described further in this manual.

**IMPORTANT: UNDER NO CIRCUMSTANCES CAN THE DRYER BE VENTED TO THE OUTDOORS USING A 6-INCH DIAMETER OR 8-INCH DIAMETER EXHAUST DUCT!!!**

### 1. Exhaust Connections of Top and Bottom Baskets (Tumblers)

There is no common venting connection provided with the dryer. Each basket (tumbler) exhaust duct is provided with its own back draft damper. Each basket (tumbler) can be exhausted directly outdoors independently (refer to the illustration [MAN1591] on **page 19**) or connected commonly ("Y") together (refer to the illustration [MAN1590] on **page 20**). Both single or common "Y" duct work can be of rigid or flexible ducting.

The illustration below shows the duct work connection points and what internal duct work is included in the dryer.

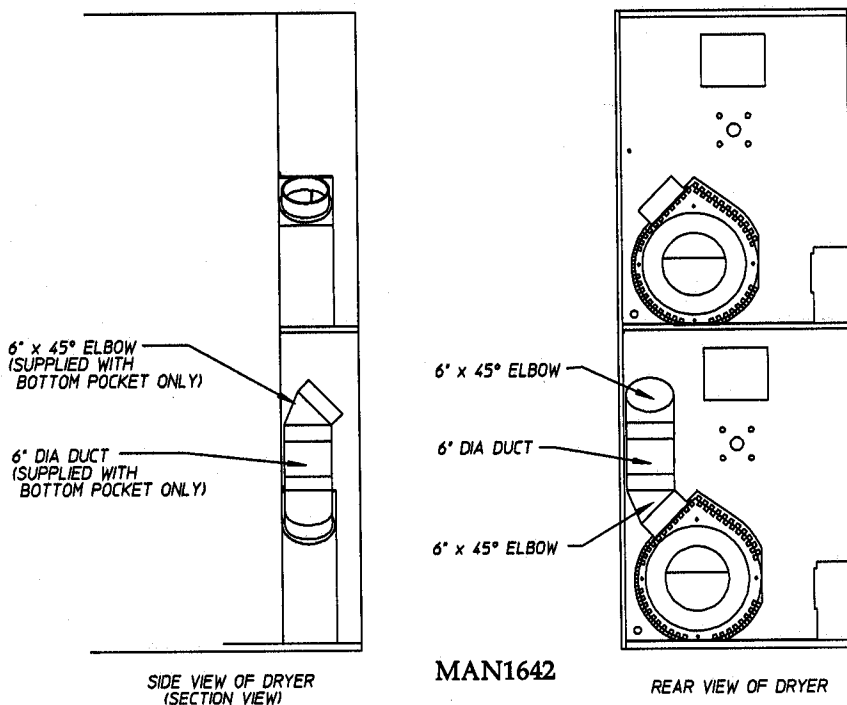

The exhaust connection at the TOP basket (tumbler) **must** be made at the blower duct inside the cabinet. **No internal duct work is included for the TOP basket/tumbler.** (Not available from ADC and **must** be purchased elsewhere). Depending on the external duct work layout, the installer has the option of the duct work coming out of the top or the back of the dryer. The duct work used inside of the dryer, from the blower duct to where it exits the dryer, **must** be a minimum of 6-inches in diameter (28 square inches cross-sectional area). At this point (where the internal ducting ends) the diameter **must** be increased to meet the application as described further in this manual.

**IMPORTANT:** When connecting duct work to the top basket (tumbler) exhaust duct, be sure that when screws are used they do not restrict the operation (both opening and closing) of the damper.

**IMPORTANT:** ALL duct work joints **must be taped** to prevent moisture and lint from escaping into the dryer and/or building.

The **BOTTOM** basket (tumbler) includes 6-inch duct work which extends from the dryer blower duct to the lower back guard area. At this point the diameter **must be increased** to meet the application as described further in this manual.

a. Connecting Both Top Basket (Tumbler) and Bottom Basket (Tumbler) Together

Both the top basket (tumbler) and the bottom basket (tumbler) can be "Y" together to form one common connection point. The bottom basket (tumbler) already includes 6-inch diameter ducting extending to the lower back guard area. The minimum connection at this point is 8-inch. The upper basket (tumbler) includes no internal duct work. (Not provided by ADC and must be purchased elsewhere, must be a minimum of 6-inches, and only to the top of the dryer.) At this point (where the internal ducting ends at top of the dryer) the diameter **must be increased** to meet the application as described further in this manual.

EXTERNAL SINGLE DRYER VENTING CONNECTIONS

(WITH DRYER COMMON EXHAUST)

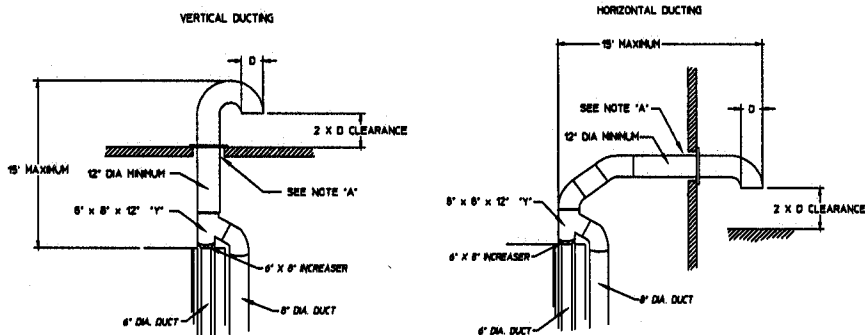

MAN1589

NOTE "A": OPENING MUST BE TWO (2) INCHES LARGER THAN DUCT (ALL THE WAY AROUND). THE DUCT MUST BE CENTERED WITHIN THIS OPENING.

**IMPORTANT:** When connecting duct work to the top basket (tumbler) exhaust duct, be sure that when screws are used they do not restrict the operation (both opening and closing) of the damper.

**IMPORTANT:** ALL duct work joints must be taped to prevent moisture and lint from escaping into the dryer and/or building.

**NOTE:** Common ("Y") exhaust connections of top basket (tumbler) and bottom basket (tumbler) should be installed in such a manner that the back guards/panels can be removed easily for servicing.

**IMPORTANT:** Exhaust back pressure measured by a manometer at each basket (tumbler) exhaust duct area should not exceed 0.3 inches water column when both baskets (tumblers) are operating.

## 2. Single Dryer Venting

Where possible, it is suggested that a separate exhaust duct be provided for each dryer. The exhaust duct work should be laid out in such a way that the duct work travels as directly as possible to the outdoors with as few turns as possible. It is suggested that the use of 90° turns in ducting be avoided; use 30° or 45° angles instead. The shape of the exhaust duct work is not critical so long as the minimum cross-sectional area is provided.

**IMPORTANT:** Exhaust back pressure measured by a manometer at the dryer exhaust duct area should not exceed 0.3 inches water column.

If the length of the duct work run or quantity of elbows used exceeds the specifications noted in this manual, the cross-sectional area of the duct work **must be** increased in proportion to the number of elbows or duct run added.

**IMPORTANT:** For extended duct work runs...or where numerous elbows are used, the cross-sectional area can only be increased to an extent and a professional HVAC firm should be consulted for proper venting information.

- a. **Single Dryer Venting** - with each basket (tumbler) independently vented all the way to the outdoors.

**IMPORTANT: UNDER NO CIRCUMSTANCES CAN THE DRYER BE VENTED TO THE OUTDOORS USING A 6-INCH DIAMETER OR 8-INCH DIAMETER EXHAUST DUCT!!!**

Where independent exhaust ducting is used for each basket (tumbler), the connection size at the point where the internal ducting (6-inch diameter) leaves the dryer, the minimum size connection is 10- inches diameter (79 square inches cross-sectional area)...and this is only true providing;

- 1) The maximum duct run is no more than 20 feet.
- 2) The duct work is a horizontal run (no riser).
- 3) There is no more than one (1) elbow ... which includes the outside outlet (i.e., elbow used for outside protection).

(Refer to the illustration [MAN1591] on **page 19** for details.)

**IMPORTANT:** Even though the dryer's exhaust outlet size is six (6) inches in diameter (at both the top basket [tumbler] damper duct and bottom basket [tumbler] elbow where it leaves the dryer), the minimum connection at the point of exit from the dryer is 12-inches in diameter (113 square inches cross-sectional area). This is true except where each basket (tumbler) (not each dryer) is independently exhausted. In this case, it's a maximum of twenty (20) feet horizontal run with no rise and only one (1) elbow (which includes outside protection) then the duct size can be 10-inches in diameter (79 square inches in cross-sectional area).

*continued on page 21*

EXTERNAL SINGLE DRYER VENTING CONNECTIONS  
( WITH DRYER INDEPENDENT EXHAUST )

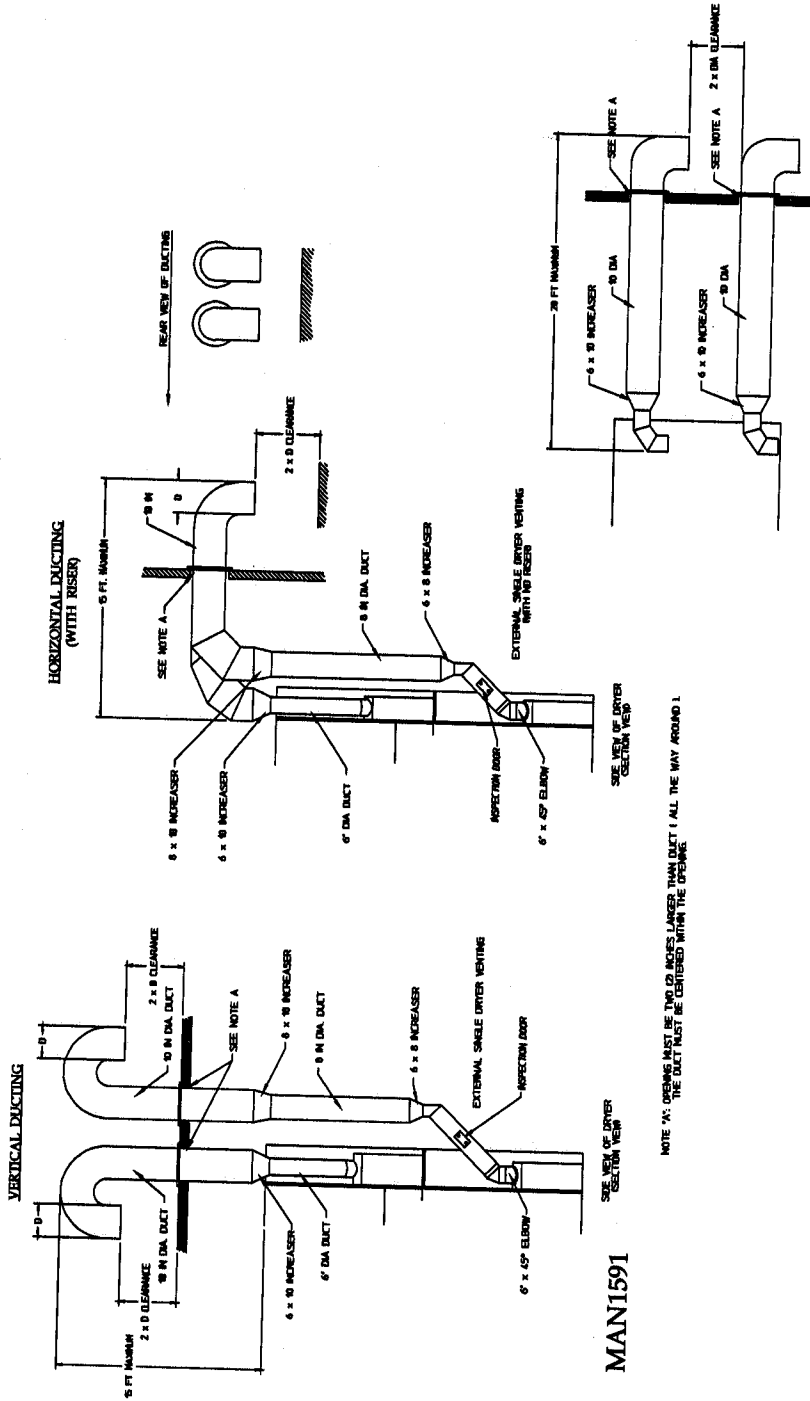

**EXTERNAL SINGLE DRYER VENTING CONNECTIONS**  
 ( WITH DRYER COMMON EXHAUST )

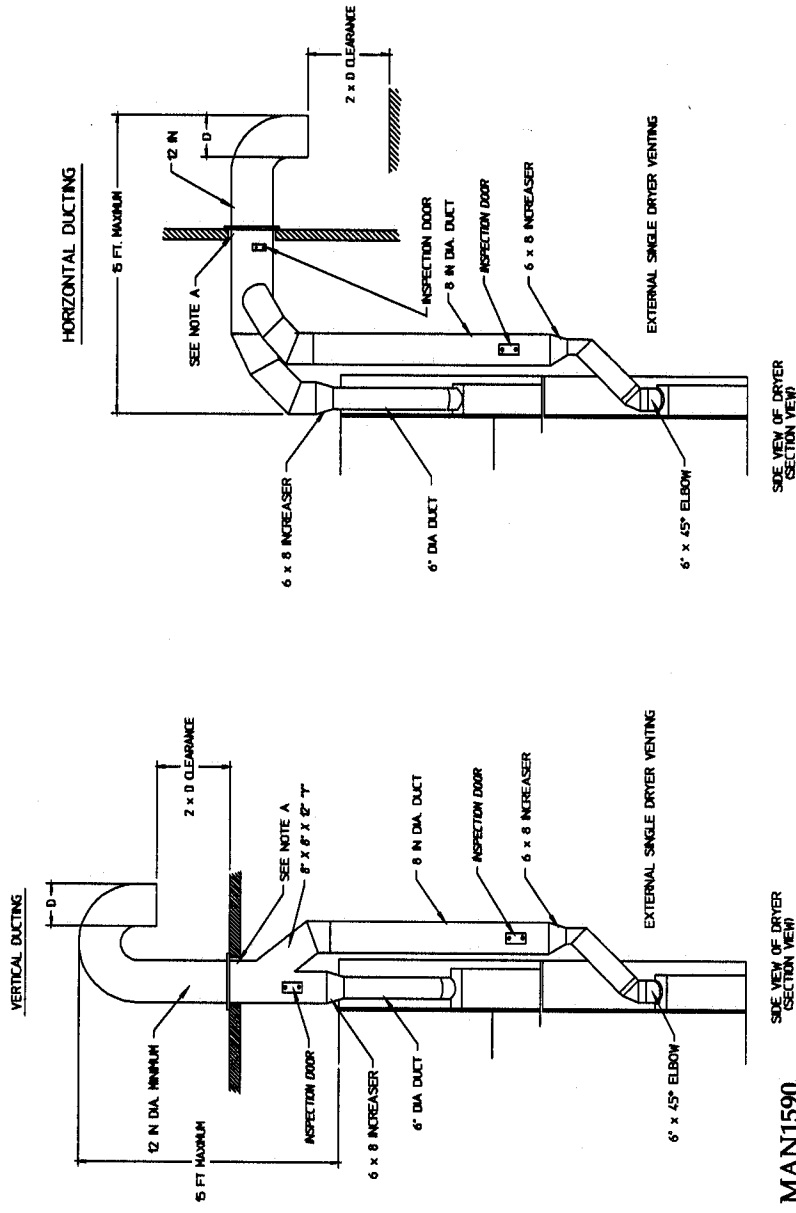

**MAN1590**

**ALL** other applications (i.e., vertical [riser] run, more elbows, etc.) require a minimum duct of 12-inches in diameter (113 square inches cross-sectional area) as shown in the illustration [MAN1591] on **page 19**. The vertical ducting need not be a minimum of 12-inches in diameter all the way into the dryer. Connections inside the dryer can be 6-inches in diameter for the top basket (tumbler) and for the bottom basket (tumbler) increased to 8-inches up to the top area of the dryer and then at that point **must** be a minimum of 12-inches in diameter (113 square inches cross-sectional area). Additionally, the length of the exhaust run **cannot** exceed fifteen (15) feet from the top of the dryer to the point where the exhaust ends outside.

- b. **Single Dryer Venting** - with common (top basket [tumbler] and bottom basket [tumbler] connected together) exhaust connections.

With the top and bottom baskets (tumblers) connected or "Y" together as noted in **Section E1**, the minimum diameter size at the "Y" or point of connection is 12 inches in diameter (113 square inches cross-sectional area). Additionally, the maximum duct work travel from the top of the dryer to the outside exhaust outlet **must not** exceed fifteen (15) feet. Refer to the illustration [MAN1590] on the previous page (**page 20**) for examples.

### 3. **Multiple Dryer Venting** (with Common Main Duct)

If it is not feasible to provide separate exhaust ducts for each dryer, ducts from individual dryers or baskets (tumblers) may be channeled into a common main duct. Each dryer/basket (tumbler) is provided with a back draft damper. The individual ducts should enter the bottom or side of the main duct at an angle of not more than 45° **in the direction of the airflow**.

The main common duct may be any shape so long as the minimum cross-sectional area is provided. The main duct **should** be tapered with the diameter increasing before each individual duct is added as per the illustration [MAN1550] on **page 23** and the illustration [MAN1549] on **page 25**.



The maximum length of venting from the last dryer to where it exhausts;

**VERTICAL** ----- venting run must not exceed eight (8) feet. This calculation compensates for the use of a maximum of three (3) elbows including the two (2) elbows creating 180° (turned downward) outside outlet.

**HORIZONTAL** - venting run must not exceed fifteen (15) feet. This calculation compensates for the use of a maximum of only one (1) elbow which is the outside outlet protection.

**IMPORTANT:** No more than four (4) dryers (eight [8] baskets [tumblers]) maximum should be connected to one (1) main common duct. Refer to the applicable section of this manual for specific common venting size.

**NOTE:** The distance between the dryer single ducts being connected to the main common duct must be a minimum of 29-5/8 inches (the dryer's width).

The duct work should be laid out in such a manner where allowances are made at the rear area of the dryer for removal of rear service panels/guards.

The illustration [MAN1550] on page 23 and the illustration [MAN1549] on page 25. show the minimum cross-sectional area for multiple dryer venting. These figures must be increased in proportion if the main duct run from the last dryer to where it exhausts, has numerous elbows, or is unusually long.

**IMPORTANT:** For extended duct work runs, the cross-sectional area of the duct can only be increased to an extent. For extended duct work runs or where numerous elbows are used, a professional HVAC firm should be consulted for proper venting information.

**NOTE:** Inspection doors should be installed at strategic points in the exhaust duct work for periodic inspection and cleaning.

a. **Multiple Dryer Venting - where each basket (tumbler) is individually vented.**

With multiple venting where each basket (tumbler) is vented independently (a separate exhaust is used for each basket [tumbler]) to the common main duct, a minimum of an 8-inch diameter duct (50 square inches cross-sectional area) connection between the dryer and common main duct is acceptable providing this duct does not exceed eight (8) feet in length.

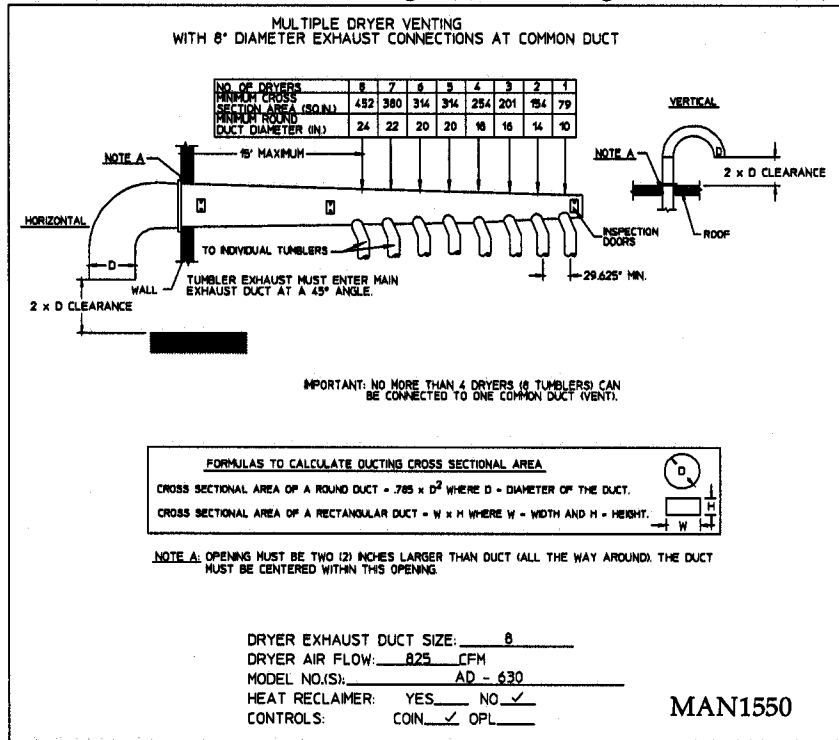

**IMPORTANT:** No more than four (4) dryers (eight [8] baskets [tumblers]) can be connected to one (1) common duct (vent).

**NOTE:** The distance between the dryer single ducts being connected to the main common duct must be a minimum of 29-5/8 inches (the dryer's width).

**NOTE:** The duct work should be laid out in such a manner where allowances are made at the rear area of the dryer for removal of rear service panels/guards.

**IMPORTANT:** Individual ducts being added to the main common vent must enter the main common vent duct work at an angle not more than 45° in the direction of the airflow.

The illustration [MAN1550] on the previous page (**page 23**) shows the minimum cross-section area for multiple (common) dryer venting.

The maximum length of venting from the last dryer to where it exhausts;

**VERTICAL** ----- venting run must not exceed eight (8) feet.

**HORIZONTAL** - venting run must not exceed fifteen (15) feet.

These figures **must be** increased in proportion if the main duct run from the last dryer has numerous elbows or is unusually long. For extended runs or where more elbows are added, the cross-sectional area of the duct can only be increased to an extent and a professional HVAC firm **should be** consulted for proper venting information.

**IMPORTANT:** Exhaust back pressure measured by a manometer at the dryer exhaust duct area **must not exceed** 0.3 inches of water column when both baskets (tumblers) are operating.

**NOTE:** Inspection doors **should be** installed at strategic points in the exhaust duct work for periodic inspection and cleaning.

- b. **Multiple Dryer Venting** - where tumblers of each dryer are "Y" together.

With multiple venting where the top basket (tumbler) and bottom basket (tumbler) are connected or "Y" together as described in Section E1 (**page 14 thru page 17**), the minimum diameter size at

the "Y" (point of connection) and main common duct is 12-inches in diameter (113 square inches cross-sectional area). This duct run cannot exceed eight (8) feet in length.

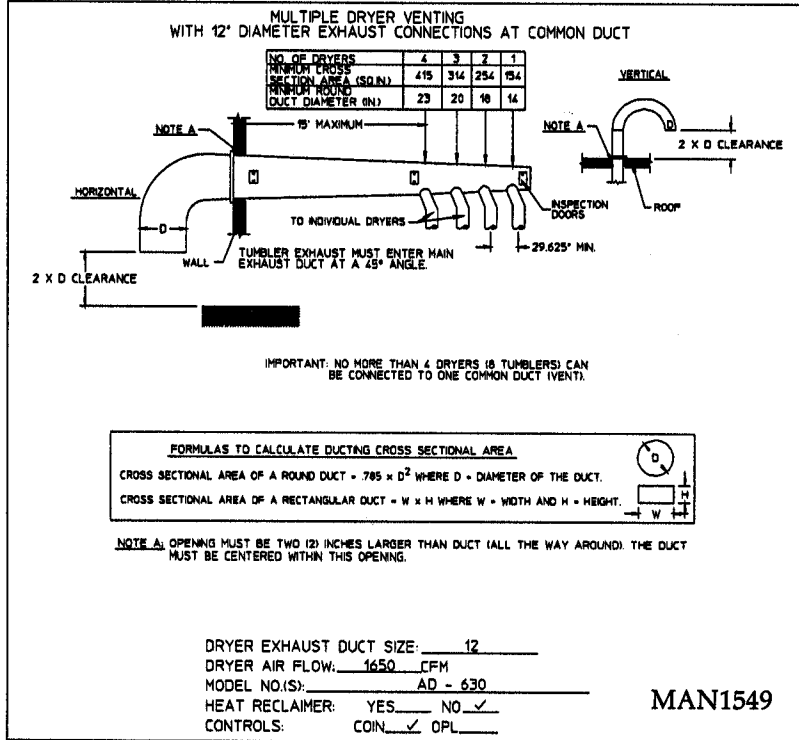

**IMPORTANT:** No more than four (4) dryers (eight [8] baskets [tumblers]) can be connected to one (1) common duct (vent).

**NOTE:** The distance between the dryer single ducts being connected to the main common duct **must be** a minimum of 29-5/8-inches (the dryer's width).

The duct work **should be** laid out in such a manner where allowances are made at the rear area of the dryer for removal of rear service panels/guards.

**IMPORTANT:** Individual ducts being added to the main common vent must enter the main common vent duct work at an angle not more than 45° in the direction of the airflow.

The illustration [MAN1549] on the previous page (page 25) shows the minimum cross-section area for multiple (common) dryer venting.

The maximum length of venting from the last dryer to where it exhausts;

**VERTICAL** ----- venting run must not exceed eight (8) feet.

**HORIZONTAL** - venting run must not exceed fifteen (15) feet.

These figures **must be** increased in proportion if the main duct run from the last dryer has numerous elbows or is unusually long. For extended runs or where more elbows are added, the cross-sectional area of the duct can only be increased to an extent and a professional HVAC firm **should be** consulted for proper venting information.

**IMPORTANT:** Exhaust back pressure measured by a manometer at the dryer exhaust duct area **must not exceed** 0.3 inches of water column when both baskets (tumblers) are operating.

**NOTE:** Inspection doors **should be** installed at strategic points in the exhaust duct work for periodic inspection and cleaning.

## Important Venting Reminders

1. Duct work sizing and installation **should be** done by a qualified professional.
2. The dryer **must be** vented to the outdoors.
3. The duct work **should be** routed as short as possible to the outdoors with as few turns as possible.
4. Avoid 90° turns ... use 30° or 45° turns instead.
5. The size (cross-sectional area) of the duct work will depend on the application (i.e., single dryer venting, common venting, etc.), as well as the length of the duct and the amount of elbows. **DO NOT** exceed the specifications noted in this manual.

**IMPORTANT: UNDER NO CIRCUMSTANCES  
CAN THE DRYER BE VENTED TO  
THE OUTDOORS USING A  
6-INCH DIAMETER OR 8-INCH  
DIAMETER EXHAUST DUCT!!!**

6. The inside of the duct work should be as smooth as possible...with no projections from sheet metal screws.

Ducts to be added should overlap the duct to which it is to be connected.

7. **ALL** ducts should be taped to prevent moisture and lint from escaping into the building.
8. Inspection/clean out doors should be installed throughout strategic points in the duct work for periodic inspection and cleaning.
9. Wherever the duct passes through combustible materials, the opening must be 2-inches larger (all the way around) than the duct. The duct must be centered within this opening.
10. The outside of the duct work must be protected from the weather. A 90° elbow must be used for a horizontal run and when going vertically through the roof by using a 180° turn to point the opening downward. The distance between the exhaust duct and the nearest obstruction (i.e., roof or ground) must be twice the diameter of the duct.
11. **DO NOT** use screens or caps on the outside opening of the exhaust duct work.
12. The duct work exhaust outlets **SHOULD NOT** be located near make-up air openings. If make up air openings are located too close to the exhaust outlet, lint and fumes may be drawn back into the dryer area through these openings.
13. Exhaust back pressure measured by a manometer at each basket (tumbler) exhaust duct area should not exceed 0.3 inches water column when both baskets (tumblers) are operating.

## F. Electrical Information

### 1. Electrical Requirements

It is your responsibility to have all electrical connections made by a properly licensed and competent electrician to assure that the electrical installation is adequate and conforms with local and state regulations or codes. In the absence of such codes, **ALL** electrical connections, material, and workmanship **must conform** to the applicable requirements of the National Electric Code ANSI/NFPA NO. 70-LATEST EDITION, or in CANADA, the Canadian Electrical Codes Parts 1 & 2 CSA C22.1-1990 or LATEST EDITION.

**IMPORTANT:** Failure to comply with these codes or ordinances, and/or the requirement stipulated in this manual can result in personal injury or component failure.

**NOTE:** Component failure due to improper installation **VOIDS THE WARRANTY.**

It is required that a separate circuit serving each basket (tumbler) be provided. The dryer **must be** connected with copper wire only. **DO NOT USE ALUMINUM WIRE WHICH COULD CAUSE A FIRE HAZARD.**

**NOTE:** The use of aluminum wire **VOIDS THE WARRANTY.**

### 2. Electrical Connections

A wiring diagram is included with each dryer showing the wiring connection sequence. The electrical connections are made in a box located at the top of the dryer. The dryer is shipped with three (3) connection points (L1, L2/Neutral, and Ground) for each basket (tumbler).

If local codes permit, power to the dryer can be made by use of a flexible U.L. listed power cord/pigtail (wire size **must conform** to rating of dryer), or the dryer can be hard wired directly to the service breaker panel. In both cases, a strain relief **must be** installed where the wiring enters the dryer.

Electrical Connection Leads		
Black + Positive	White - Neutral	Green Ground
(L1)	(L2)	(GND)

**NOTE: IT IS REQUIRED** that a circuit serving each basket (tumbler) be provided.

3. Grounding (earth) connection **must be** provided and installed in accordance with state and local codes. In the absence of these codes, grounding **must conform** to applicable requirements of the NATIONAL ELECTRIC CODE ANSI/NFPA No. 70-LATEST EDITION, or in CANADA, the Canadian Electrical Codes Parts 1 & 2 CSA C22.1-1990 or LATEST EDITION. The ground connection may be to a proven earth ground at the location service panel.

For added personal safety, when possible, it is suggested that a separate ground wire (sized per local codes) be connected from the ground connection of the dryer to a grounded cold water pipe. **DO NOT ground to a gas pipe or hot water pipe.** The grounded cold water pipe **must have** metal to metal connections all the way to the electrical ground. If there are any non-metallic interruptions, such as, a meter, pump, plastic, rubber, or other insulating connectors, they **must be** jumped out with #4 wire and securely clamped to bare metal at both ends.

**IMPORTANT:** For personal safety and proper operation, the dryer **must be** grounded.



4. Electrical Service Specifications (Per Pocket)

**IMPORTANT:** The dryer **must be** connected to the electrical supply shown on the data label located behind the middle access (control) door, on the right wall, adjacent to the gas valve train (refer to **SECTION IX [page 63 and page 64]** of this manual).

**WARNING:** Any damage done to dryer components due to improper voltage application or connections will automatically **VOID THE WARRANTY.**

**AD-630 Electrical Specifications (Per Pocket)**

**IMPORTANT:** 208 VAC and 230/240 VAC **ARE NOT THE SAME.** When ordering, specify exact voltage.

- NOTE:** 1. Fuse ratings are dual element-time-delay-current limiting, class RK1 or RK5 ONLY.  
 2. Circuit breakers are thermal magnetic (industrial) type ONLY. For others, calculate/verify correct breaker size according to appliance amp draw rating and type of breaker used.

SERVICE VOLTAGE	PHASE	WIRE SERVICE	APPROX. AMP DRAW	MINIMUM WIRE SIZE*	FUSING	CIRCUIT BREAKER
					Dual Element Time Delay	
115	1ø	2	14	10	20	25
208	1ø	2	7	12	10	15
230	1ø	2	6.6	12	10	15
240	1ø	2	6.6	12	10	15

\* AWG Stranded Type Wire...for individual lengths under 100 feet.

**NOTE:** Contact factory for electrical information not listed.

**NOTE:** ADC reserves the right to make changes in specifications at any time, without notice or obligation.

## G. Gas Information

It is your responsibility to have **ALL** plumbing connections made by a qualified professional to assure that the gas plumbing installation is adequate and conforms with local and state regulations or codes. In the absence of such codes, all plumbing connections, material, and workmanship **must conform** to the applicable requirements of the National Fuel Gas Code ANSI Z223.1-LATEST EDITION, or in CANADA, the Canadian Installation Codes CAN/CGA-B149.1-M91 (Natural Gas) or CAN/CGA-B149.2-M91 (L.P. GAS) or LATEST EDITION.

**IMPORTANT:** Failure to comply with these codes or ordinances, and/or the requirements stipulated in this manual can result in personal injury and improper operation of the dryer.

The dryer and its individual shut-off valves **must be** disconnected from the gas supply piping system during any pressure testing of that system at test pressures in excess of 1/2 psig (3.5 kPa).

The dryer **must be** isolated from the gas supply piping system by closing its individual manual shut-off valves during any pressure testing of the gas supply piping system at test pressures equal to or less than 1/2 psig (3.5 kPa).

**IMPORTANT:** Failure to isolate or disconnect dryer from supply as noted can cause irreparable damage to the gas valves...**VOIDING THE WARRANTY.**

**WARNING: FIRE or EXPLOSION COULD RESULT.**

### 1. Gas Supply

The gas dryer installation **must meet** the American National Standard, National Fuel Gas Code ANSI Z223.1-LATEST EDITION, or in CANADA, the Canadian Installation Codes CAN/CGA-B149.1-M91 (Natural Gas) or CAN/CGA-B149.2-M91 (L.P. GAS) or LATEST EDITION, as well as local codes and ordinances and **must be** done by a qualified professional.

**NOTE:** Undersized gas piping will result in ignition problems, slow drying, and increased use of energy and can create a safety hazard.

The dryer **must** be connected to the type of heat/gas indicated on the dryer data label located behind the middle access (control) door, on the right wall, adjacent to the gas valve train (refer to **SECTION IX [page 63 and page 64]** of this manual). If this information **does not** agree with the type of gas available, contact the distributor who sold the dryer or the ADC factory.

**IMPORTANT:** Any burner changes or conversions **must** be made by a qualified professional.

The input ratings shown on the dryer data label are for elevations of up to 2,000 feet unless elevation requirements of over 2,000 feet were specified at the time the dryer order was placed with the factory. The adjustment for dryers in the field for elevations over 2,000 feet are made by changing each burner orifice. If this adjustment is necessary, contact the distributor who sold the dryer or contact the ADC factory.

## 2. Technical Gas Data

### a. Gas Specifications

	Type of Gas	
	Natural	Liquid Propane (L.P.)
Manifold Pressure*	3.5 - 4.0 inches W.C.	10.5 - 11.0 inches W.C.
Inline Pressure	6.0 - 12.0 inches W.C.	11.0 inches W.C.

\* Measured at gas valve pressure tap when the gas valve is on.  
W.C. = Water Column measured in inches.

ADG-630D	
Gas Inlet Size (for each basket/tumbler)	3/4" N.P.T.
Btu/hr Input (for each basket/tumbler)	122,500
Btu/hr Input (total for both baskets/tumblers)	245,000

N.P.T. = National Pipe Thread

b. Natural Gas

Regulation is controlled by each gas valve's internal regulator. Incoming supply pressure **must be consistent** between a minimum of 6.0 inches and a maximum of 12 inches water column pressure.

c. Liquid Propane (L.P.) Gas

Dryers made for use with L.P. gas have the gas valve's pressure regulator blocked open so that the gas pressure **must be regulated** upstream of the dryer. The pressure measured at each gas valve body pressure tap **must be a consistent** 10.5 inches water column. There is no regulator provided in an L.P. dryer. The water column pressure **must be regulated** at the source (L.P. tank), or an external regulator **must be added** to each dryer.

3. Piping/Connections

**ALL** components/materials **must conform** to National Fuel Gas Code specifications, or in CANADA, the Canadian Installation Codes (for General Installation and Gas Plumbing).

It is important that gas pressure regulators meet applicable pressure requirements and that gas meters be rated for the total amount of **ALL** the appliance Btu's being supplied.

The dryer is provided with two (2) 3/4" N.P.T. inlet pipe connections (one for each basket/tumbler) at the rear of the dryer. If a separate feed is provided for each basket (tumbler) from the main supply line (header), then a 3/4" line connection is sufficient. However, if the top basket (tumbler) and the bottom basket (tumbler) connections are connected together, the supply from the header **must be increased** to 1-inch (maximum fifty [50] feet to the header). For typical gas connections refer to the **illustration** on the next page (**page 34**). It is recommended that a gas shut-off valve be provided to the gas supply line of each dryer for ease in servicing.

The size of the gas supply line (header) will vary, depending on the distance this supply line travels from the gas meter (or in the case of L.P. gas, the supply tank), the number of tees, other gas-operated appliances on the supply line, etc. Specific information regarding supply line size **should be determined** by the gas supplier.

*continued on page 35*

## TYPICAL GAS CONNECTIONS

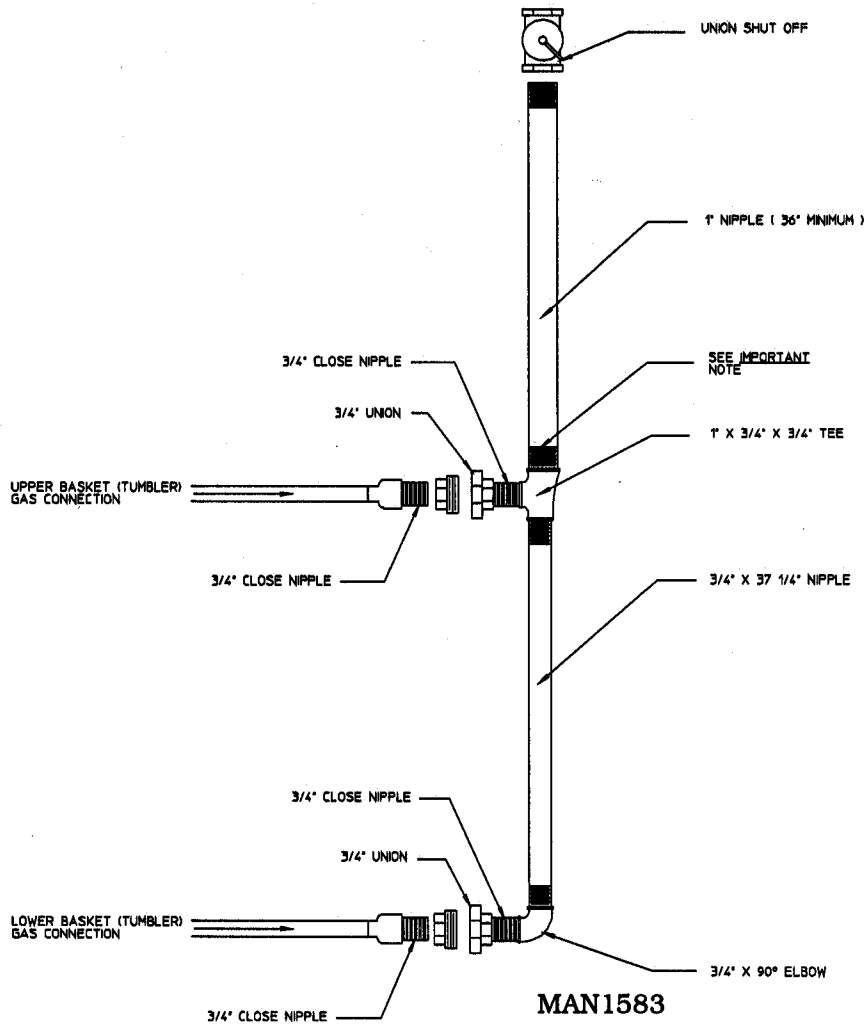

**IMPORTANT:** WHEN PLUMBING UPPER and LOWER BASKETS (TUMBLERS) TOGETHER, AS ILLUSTRATED ABOVE, SUPPLY CONNECTION **MUST BE A MINIMUM OF 1'.**

### PLUMBING LIST

Qty.	Description
1	1" Union Shut-Off
1	1" x 36" (minimum) Nipple
1	3/4" x 37-1/4" Nipple
1	1" x 3/4" x 3/4" Tee
4	3/4" Close Nipple
2	3/4" Union
1	3/4" x 90° Elbow

**NOTE:** Undersized gas supply piping can create a low or inconsistent gas pressure which will result in erratic operation of the burner ignition system.

Consistent gas pressure is essential at **ALL** gas connections. It is recommended that a 3/4" pipe loop be installed in the supply line serving the bank of dryers. An in-line pressure regulator **must be** installed in the gas supply line (header) if (natural) the gas line pressure exceeds 12.0 inches water column pressure. Refer to the illustration on the following page (page 36) for details.

**IMPORTANT:** Water column pressure of 4.0 inches for natural gas dryers and 10.5 inches for L.P. gas is required at the gas valve pressure tap of each dryer for proper and safe operation.

A 1/8" N.P.T. plugged tap, accessible for a test gauge connection, **must be** installed in the main gas supply line immediately upstream of each dryer.

**IMPORTANT:** Pipe joint compounds that resist the action of natural and L.P. gases **must be** used.

**WARNING:** Test **ALL** connections for leaks by brushing on a soapy water solution (liquid detergent also works well). **NEVER TEST FOR GAS LEAKS WITH AN OPEN FLAME.**

### TYPICAL NATURAL GAS INSTALLATION

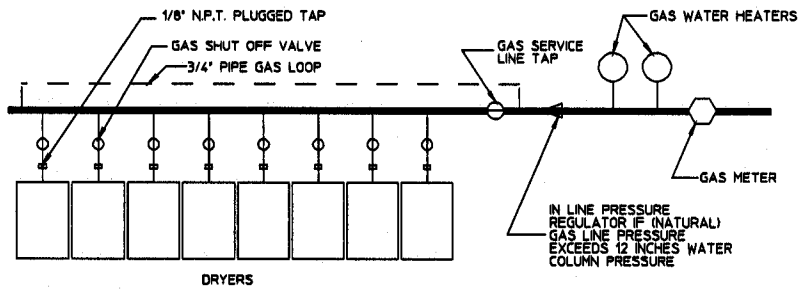

### TYPICAL LIQUID PROPANE (L.P.) GAS INSTALLATION

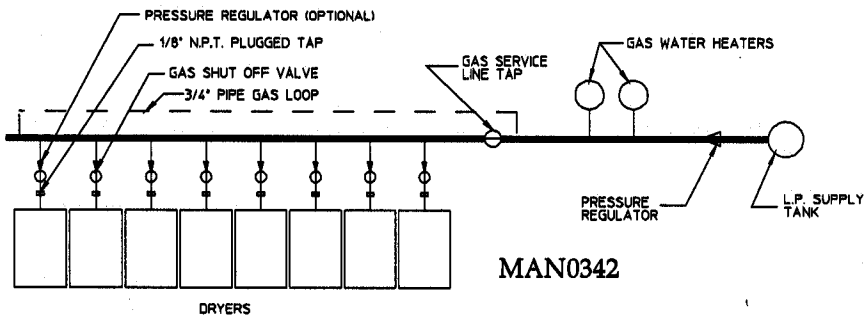

MAN0342

## H. Preparation For Operation

The following items **should** be checked before attempting to operate the dryer:

1. Read and follow **ALL** "CAUTION," "WARNING," and "DIRECTION" labels attached to the dryer.
2. Check incoming supply voltage to be sure that it is the same as indicated on the dryer data label located behind the middle access (control) door, on the right wall, adjacent to the gas valve train (refer to **SECTION IX** [**page 63** and **page 64**] of this manual).
3. Check to assure that the dryer is connected to the type of heat/ gas indicated on the dryer data label.
4. The sail switch damper assemblies are installed and pre-adjusted at the factory prior to dryer shipment. However, each sail switch adjustment **should** be checked to assure that this important safety control is functioning.
5. Check bolts, nuts, screws, terminals, and fittings for security.
6. Be sure **ALL** gas shut-off valves are in the open position.
7. Be sure **ALL** back panels (guards) and electric box covers have been replaced.
8. Check **ALL** service doors to assure that they are closed and secured in place.
9. Rotate the baskets (tumblers) by hand to be sure they move freely.

## I. Preoperational Tests

**ALL** dryers are thoroughly tested and inspected before leaving the factory. However, a preoperational test **should** be performed before the dryer is publicly used. It is possible that adjustments have changed in transit.

1. Turn On Electrical Power To The Dryer
  - A) Open **ALL** gas shut-off valves.



## 2. Dual Microprocessor Controller (DMC) Computer System Operational Test

### a. *COIN MODELS ONLY*

- 1) The L.E.D. display(s) will flash back and forth between "FILL" and the amount needed to start the dryer (i.e., "25"), which means that the dryer is available and 25¢ is required to start it.
- 2) Insert the proper number of coins into coin acceptor. Once the correct amount needed to start the dryer has been inserted, the L.E.D. display(s) will read "PUSH" . . . "tEnP".
- 3) Start the dryer by pressing the desired setting for either the upper basket/tumbler or the lower basket/tumbler (i.e., "LO" selection for the upper basket/tumbler). The L.E.D. display will now read selection (setting) made and the amount of time vended (i.e., "LO 10").

**NOTE:** The dryer can be stopped at any time by opening the main door. To restart dryer, shut the main door and press desired setting.

- 4) Open main door to stop the dryer, and change selection to "PERM PRESS" (medium) setting. Repeat this procedure, but change the selection (setting) to "HI" (high). This will confirm that the selection key circuits and door switch circuits are functioning properly.

**NOTE:** Selection (setting) changes can be made at any time during the drying cycle by opening and closing the main door and then making a new selection.

- 5) Repeat above procedure for the other basket (tumbler).

### b. *OPL (NON-COIN) MODELS ONLY*

- 1) The L.E.D. display(s) will read "FILL", which means that the dryer is available.

- 2) Start the dryer by pressing the desired setting for either the upper basket/tumbler or the lower dryer basket/tumbler (i.e., "LO" selection for the upper basket [tumbler]). The L.E.D. display will now read selection (setting) made and the drying time portion of the L.E.D. display will read "00" and count upwards in time.

**NOTE:** The dryer can be stopped at any time by opening the main door. To restart the dryer, shut the main door and press the desired setting.

- 3) Open main door to stop the dryer, and change selection to "PERM PRESS" (medium) setting. Repeat this procedure, but change the selection (setting) to "HI" (high). This will confirm that the selection key circuits and door switch circuits are functioning properly.

**NOTE:** Selection (setting) changes can be made at any time during the drying cycle by opening and closing the main door and then making a new selection.

- 4) Repeat above procedure for the other basket (tumbler).

### 3. Heat Circuit Operational Test

#### a. *GAS MODELS*

When a gas dryer is first started (during the initial start-up), it has a tendency not to ignite on the first attempt. This is because the gas supply piping is filled with air. It may take a few minutes for this air to be purged from the lines.

The dryer is equipped with a Direct Spark Ignition (DSI) system which has internal diagnostics. If ignition is not established, the heat circuit DSI module will lock out until it is manually reset. To reset the DSI system, open and close the main door and restart the dryer (press desired temperature selection).

**NOTE:** During the purging period, check to be sure that **ALL** gas shut-off valves are open.

Once ignition is established, a gas pressure reading should be taken at the gas valve pressure tap of each dryer to assure that the water column pressure is correct and consistent.

**NOTE:** Water column pressure requirements (measured at the gas valve pressure tap from the manifold side of the gas valve):

Natural Gas .... 3.5 Inches W.C.  
L.P. Gas ..... 10.5 Inches W.C.

**IMPORTANT:** THERE IS NO REGULATOR PROVIDED IN AN L.P. DRYER. The water column pressure must be regulated at the source (L.P. tank) or an external regulator must be added to each dryer.

4. Make A Complete Operational Check Of ALL Safety-Related Circuits (i.e., lint basket switches and sail switches).

**NOTE:** The sail switch can be checked for proper operation by opening the middle access (control) door while the dryer is running and the heating unit (burner) active (on). The heating unit(s) should shut off within a few seconds. If not, make the necessary adjustments.

5. Each Basket (tumbler) SHOULD BE Operated Through One (1) Complete Cycle to assure that no further adjustments are necessary and that **ALL** components are functioning properly.

**IMPORTANT:** The dryer baskets (tumblers) are treated with a protective coating. This coating can be removed by tumbling old clothes or material in the baskets (tumblers) using a mild detergent to remove the protective coating.

**NOTE:** Drying and cooling cycles are complete when the L.E.D. display reads..."done".

## 6. Computer Programs/Selections

Each Dual Microprocessor Controller (DMC) computer has been preprogrammed by the factory with the most commonly used program (parameter) selections. If microprocessor (computer) program changes are required, refer to the Dual Microprocessor Controller (DMC) Programming Manual which was shipped with the dryer.

# SECTION IV

## OPERATING INSTRUCTIONS

### A. Starting The Dryer

#### 1. *COIN DRYERS*

The dryer is available for use when the L.E.D. display reads "FILL" and/or the amount needed to start the dryer (i.e., "25"). Once the load has been put into the dryer and the main door is closed, start the dryer as follows:

- a. Insert the proper number of coins into the coin acceptor. Once the correct "Amount To Start" has been inserted, the L.E.D. displays will read "PUSH" . . . "tEnP".
- b. Determine fabric setting (selection). "HI TEMP" is the high temperature range, "PERM PRESS" is the medium-range temperature setting, and "LO TEMP" is the low-range temperature.

Once the fabric temperature setting (selection) has been determined, you start the dryer by pressing the fabric setting key for the basket (tumbler) being used (i.e., "LO TEMP" setting for the upper basket [tumbler]).

- c. The dryer will now start, and the L.E.D. display for the basket (tumbler) selected will read the setting and the time vended (i.e., "LO 10").
- d. The cycle time will count down until the drying and cooling cycles are completed.
- e. Upon completion of the drying cycle and cooling cycle, the dryer will shut off, the tone (buzzer) will sound for five (5) seconds, and the L.E.D. display will read "donE".

**NOTE:** If the Anti-Wrinkle program is active, the L.E.D. display will remain reading "donE", and the Dual Microprocessor Controller (DMC) computer will proceed through the Anti-Wrinkle program until the maximum "Active Guard Time" has expired or until the main door is opened, whichever comes first.

**NOTE:** If the Anti-Wrinkle program is not active or in use, the L.E.D. display will read "donE" until the main door is opened, at which time, the L.E.D. display will read "FILL" and the "Amount To Start."

f. *Notes*

- 1) The dryer basket (tumbler) can be stopped at any time by opening the main door. To restart dryer, shut the main door and press desired setting.

**NOTE:** When a cycle is interrupted by opening the main door, cycle time will continue to count downward, regardless if the door is open or closed, until a keyboard (touch-pad) selection is made.

- 2) Selection (setting) changes can be made at any time during the drying cycle by opening and closing the main door and then making a new selection.
- 3) Additional time can be purchased at any time. If the dryer is in operation (drying mode) and additional coins are inserted, the L.E.D. display(s) will read "PUSH" . . . "tEnP", and the selection (setting) key for the appropriate basket (tumbler) **must be** pressed.

**NOTE:** Any one of the three (3) selection keys can be pressed for the appropriate basket (tumbler). No matter which key is pressed, the Dual Microprocessor Controller (DMC) computer will continue the cycle selection time that was in operation at the time of inserting additional coins.

**NOTE:** When both baskets (tumblers) are in operation and additional coins are inserted for one basket (tumbler) and the appropriate basket (tumbler) selection is made, the other basket (tumbler) automatically resumes cycle status.

## 2. *NON-COIN (OPL) DRYERS*

The dryer is available for use when the L.E.D. display reads "FILL". Once the load has been put into the dryer and the main door is closed, start the dryer as follows:

- a. Determine fabric setting (selection). The "HI TEMP" setting is in the high-temperature range, the "PERM PRESS" is in the medium-temperature range, and the "LO TEMP" setting is in the low-temperature range.
- b. Once the fabric temperature setting (selection) has been determined, you start the dryer by pressing the fabric setting key for the basket (tumbler) being used (i.e., "LO TEMP" setting for the upper basket [tumbler]).
- c. The dryer will now start, and the L.E.D. display for the basket (tumbler) selected will read the setting (selection) and the drying portion of the L.E.D. display will read "00" and count upwards in time.
- d. Upon completion of the drying cycle and cooling cycle, the dryer will shut off, the tone (buzzer) will sound for five (5) seconds, and the L.E.D. display will read "donE".

**NOTE:** If the Anti-Wrinkle program is active, the L.E.D. display will remain reading "donE", and the Dual Micro-processor Controller (DMC) computer will proceed through the Anti-Wrinkle program until the maximum "Active Guard Time" has expired or until the main door is opened, whichever comes first.

**NOTE:** If the Anti-Wrinkle program is not active or in use, the L.E.D. display will read "donE" until the main door is opened, at which time the L.E.D. display will read "FILL".

e. *Notes*

- 1) The dryer basket (tumbler) can be stopped at any time by opening the main door. To restart dryer, shut the main door and press desired setting.

**NOTE:** When a cycle is interrupted by opening the main door, cycle time will continue to count upward, regardless if the door is open or closed, until a keyboard (touchpad) selection is made.

- 2) Selection (setting) changes can be made at any time during the drying cycle by opening and closing the main door and then making a new selection.

## **B. Shut Down Instructions**

In the case where the dryer is to be shut down (taken out of service) for a period of time, the following **MUST BE** performed;

1. Discontinue power to the dryer (both baskets [tumblers]) either at the external disconnect switch or the circuit breaker.
2. Discontinue the gas supply:
  - a. Shut off **external gas supply shut off valve** (for both the top basket [tumbler] and the bottom basket [tumbler] where the independent supply line to each basket [tumbler] is used).
  - b. Shut off **internal gas supply shut off valve located at the gas valve train area** (for both the top basket [tumbler] and the bottom basket [tumbler]).



# SECTION V

## SERVICE/PARTS INFORMATION

### A. Service

1. Only properly licensed or trained technicians should service the dryer. If service is required, contact the distributor from whom the ADC equipment was purchased. If the distributor **cannot** be contacted or is unknown, contact the ADC Service Department for a distributor in your area.

**NOTE:** When contacting the ADC Service Department, be sure to give them the correct **model number** and **serial number** so that your inquiry can be handled in an expeditious manner.

### B. Parts

1. Replacement parts **should be** purchased from the distributor from whom the ADC equipment was purchased. If the distributor **cannot** be contacted or is unknown, contact the ADC Parts Department for a distributor in your area. Parts may also be purchased directly from the factory by faxing to (508) 678-9447 or calling the ADC Parts Department at (508) 678-9010.

**NOTE:** When ordering directly from the ADC Parts Department, be sure to give them the correct **model number** and **serial number** so that your parts order can be processed in an expeditious manner.

# SECTION VI

## WARRANTY INFORMATION

### A. Returning Warranty Card(s)

1. Before any dryer leaves the ADC test booth area, a warranty card is affixed to the glass of the main door. These warranty cards are intended to serve the customer in two ways. First when ADC receives the warranty card(s) back from a customer, we mail the appropriate parts manual to the address indicated on the returned card at no charge to the customer. Second, we record the individual installation date of that specific dryer so as to extend the customer's warranty period.
  - a) If a warranty card **does not** come with the individual dryer, contact the ADC Warranty Department or Service Department at (508) 678-9000.

**IMPORTANT:** A separate warranty card **must be** completed and returned for each individual dryer.

**NOTE:** Be sure to include the installation date when returning warranty card(s).

### B. Warranty

For a copy of the ADC commercial warranty covering your particular dryer(s), contact the ADC distributor from whom you purchased the equipment and request a commercial dryer warranty form. If the distributor **cannot** be contacted or is unknown, warranty information can be obtained from the factory by contacting the ADC Warranty Department at (508) 678-9000.

**NOTE:** Whenever contacting the ADC factory for warranty information, be sure to have the dryer(s) **model number** and **serial number** available so that your inquiry can be handled in an expeditious manner.

## C. Returning Warranty Parts

ADC has a Warranty Parts Department that handles all returned warranted merchandise. To expedite processing, the following procedures **must be followed**:

1. **No** parts are to be returned to ADC without prior written authorization ("Return Material Authorization") from the factory.

**NOTE:** R.M.A.'s are valid for only sixty (60) days from date of issue.

- a) The R.M.A. issued by the factory, as well as any other correspondence pertaining to the returned part(s), **must be included** inside the package with the failed merchandise.
2. Each part **must be tagged** with the following information:
    - a) The **model number** and **serial number** of dryer from which part was removed.
    - b) Nature of Failure (be specific).
    - c) Date of Dryer Installation.
    - d) Date of Part Failure.
    - e) Specify whether the part(s) being returned is for a **replacement**, a **credit**, or a **refund**.

**NOTE:** If a part is marked for a credit or a refund, the invoice number covering the purchase of the replacement part **must be provided**.

**NOTE:** Warranty Tags (ADC Part No. 450064) are available at "No Charge" from ADC upon request.

3. The company returning the part(s) must clearly note the complete company name and address on the outside of the package.
4. **ALL** returns must be properly packaged to insure that they are not damaged in transit. **NO** replacements, credits, or refunds will be issued for merchandise damaged in transit. Damage claims are the responsibility of the shipper.
5. **ALL** returns should be shipped to the ADC factory in such a manner that they are insured and a proof of delivery can be obtained by the sender.
6. Shipping charges **are not** the responsibility of ADC. **ALL** returns **should be** prepaid to the factory. **Any "COD" or "COLLECT" returns will not be accepted.**

**IMPORTANT:** **NO** replacements, credits, or refunds will be issued if the claim **cannot** be processed due to insufficient information. The party that is filing the claim will be notified in writing by "Certified Mail - Return Receipt Requested," as to the information necessary to process the claim. If a reply is not received by the ADC Warranty Parts Department within thirty (30) days of the letter date, then **no replacement, credit, or refund** will be issued, and the merchandise **will be discarded**.

# SECTION VII

## ROUTINE MAINTENANCE

### A. Cleaning

A program or schedule **should be** established for periodic inspection, cleaning, and removal of lint from various areas of the dryer as well as throughout the duct work system. The frequency of cleaning can best be determined from experience at each location. **Maximum operating efficiency is dependent upon proper air circulation.** The accumulation of lint can restrict this airflow. If the guidelines in this section are met, your new dryer will provide many years of efficient, trouble-free, and - most importantly - safe operation.

**WARNING: LINT FROM MOST FABRICS IS HIGHLY COMBUSTIBLE. THE ACCUMULATION OF LINT CAN CREATE A POTENTIAL FIRE HAZARD.**

**WARNING: KEEP DRYER AREA CLEAR and FREE FROM COMBUSTIBLE MATERIALS, GASOLINE, AND FLAMMABLE VAPORS and LIQUIDS.**

**WARNING: TO AVOID THE HAZARD OF ELECTRICAL SHOCK, DISCONTINUE ELECTRICAL POWER TO THE DRYER.**

**NOTE: Suggested time intervals shown are for average usage which is considered six (6) to eight (8) operational running hours per day.**

#### *DAILY (beginning of each work shift)*

Clean lint from basket(s)/tumbler(s).

Inspect lint screen(s)/drawer(s) for damage and replace if torn.

## **WEEKLY**

Clean lint accumulation from around microprocessor temperature sensor probes and sensor bracket assemblies.

## **90 DAYS**

Remove lint from the motor air vents and surrounding area.

**IMPORTANT:** Lint accumulation will restrict the airflow over the motor(s), causing overheating and irreparable motor damage. Motor failure due to lint accumulation will VOID THE WARRANTY.

Remove lint accumulation from around the openings in the dryer's back panels.

Remove lint from gas valve burner train area with a dusting brush or vacuum cleaner attachment.

Remove any lint accumulation from the coin acceptor area, including the optical switch.

Inspect and remove lint accumulation in customer-furnished exhaust duct work system and from the dryer's internal exhaust ducting.

**WARNING:** THE ACCUMULATION OF LINT IN THE EXHAUST DUCT WORK CAN CREATE A POTENTIAL FIRE HAZARD.

**WARNING:** DO NOT OBSTRUCT THE FLOW OF COMBUSTION AIR and VENTILATION AIR.

Inspect and remove lint accumulation from the dryer's exhaust duct work back draft dampers.

**NOTE:** A back draft damper that is sticking partially closed can result in slow drying and shutdown of the heat circuit safety switches and/or thermostats.

## 6 MONTHS

In the cleaning of the dryer cabinet, avoid using harsh abrasives. A product for the cleaning of appliances is recommended.

**ALL** bearings and set screws should be checked to insure they are tight.

## B. Adjustments

### *7 Days After Installation and Every 6 Months Thereafter*

Inspect bolts, nuts, screws (bearing set screws), non-permanent gas connections (unions, shut-off valves, orifices, etc.), electrical terminations, and grounding connections.

The 12-Rib 95" (J) poly belt arrangement should be examined. A cracked or seriously frayed belt(s) should be replaced. Tighten loose belt(s) when necessary and check the alignment.

Inspect drive (motor/impellor [fan]) shaft belt. A cracked or seriously frayed belt(s) should be replaced. Tighten loose belt(s) when necessary and check the alignment.

Complete operational check of controls and valves.

Complete operational check of **ALL** safety devices (door switches, lint compartment switches, sail switches, burner and hi-limit thermostats).

## C. Lubrication

The motor bearings, idler bearings, and tumbler bearings are permanently lubricated. **No lubrication is necessary.**

# SECTION VIII

## TROUBLESHOOTING

The information provided is a quick reference to help isolate the most probable component(s) associated with the difficulty described. The experienced technician realizes, however, that a loose connection or broken or shorted wire may be at fault where electrical components are concerned. . . not necessarily the suspect component itself.

Electrical parts should always be checked for failure before being returned to the factory.

The information provided should not be misconstrued as a handbook for use by an untrained person in making repairs.

**IMPORTANT:** When replacing blown fuses, the replacement **must be** of the exact rating as the fuse being replaced.

**WARNING:** **ALL SERVICE** and TROUBLESHOOTING **SHOULD BE PERFORMED BY A QUALIFIED PROFESSIONAL.**

**WARNING:** WHILE MAKING REPAIRS, OBSERVE **ALL SAFETY PRECAUTIONS DISPLAYED ON THE DRYER** and/or SPECIFIED IN THIS MANUAL.

### A. No L.E.D. Display...

1. Service panel fuse blown or tripped breaker.
2. Blown control circuit fuse (3AG 1/2-Amp [Slo Blo] Fuse).
3. Failed Dual Microprocessor Controller (DMC) computer.

### B. Basket (tumbler) motor does not start, DMC computer shows drying cycle in progress and L.E.D. motor indicator dot is on...



1. Dual Microprocessor Controller (DMC) computer indicator is on ...
  - a. Failed motor contactor/relay.
  - b. Failed motor.
2. Dual Microprocessor Controller (DMC) computer indicator is off (and L.E.D. display does not read "door") ...
  - a. Failed Dual Microprocessor Controller (DMC) computer.
- C. Basket (tumbler) does not turn but motor, DMC computer motor L.E.D. dot, and motor output L.E.D. indicators are on...**
  1. Loose tumbler/basket belt (check tension/adjustment).
  2. Tumbler/basket belt jumped off of the motor or idler shaft.
  3. Broken basket (tumbler) belt.
- D. The dryer will not stop, even with no cycle (L.E.D. display reads "FILL") in progress...**
  1. Failed motor contactor/relay.
- E. The dryer operates for a few minutes, and with the DMC computer motor L.E.D. indicator dot on the motor stops, and then after a period of time restarts on it's own...**
  1. Motor is overheating and tripping out on its' internal overload ...
    - a. Motor air vents clogged with lint.
    - b. Low voltage to the motor.
- F. The dryer operates for a few minutes and then stops...DMC computer L.E.D. display continues to read cycle in progress, indicator dots are off and dryer can be restarted by pressing selection key...**
  1. Intermittent connection in the main door/lint drawer circuit ...

- a. Main door switch or lint drawer switch out of proper adjustment.
  - b. Loose connection in main door switch or lint drawer switch wiring.
  - c. Failed main door switch or lint drawer switch.
- G. The dryer does not start, and the DMC computer L.E.D. display reads "door"...**
- 1. Dual Microprocessor Controller (DMC) "door" input L.E.D. is off ...
    - a. Main door and/or lint drawer is not properly closed.
    - b. Failed main door switch.
    - c. Failed lint drawer switch.
    - d. Open circuit (broken wire and/or termination) in main door switch circuit wiring or lint drawer switch circuit wiring.
    - e. Failed 24 VAC step down transformer.
  - 2. Dual Microprocessor Controller (DMC) "door" input L.E.D. is on ...
    - a. Failed Dual Microprocessor Controller (DMC) computer.
- H. The dryer does not start (COIN MODELS ONLY)...coin(s) inserted and the L.E.D. display continues to read "FILL" and/or "Amount to Start" (does not read "PUSH")...**
- 1. Coin acceptor is not adjusted properly (housing is not flush with panel) or is dirty with lint.
  - 2. Failed coin acceptor optic switch.
  - 3. Parameter in Program Location 01 (PL01) set incorrectly.
    - a. Bad coin program should be set for "bCrS" and not "bCLO."
- I. DMC computer L.E.D. display reads "dSFL"...**

1. L.E.D. display consistently reads "dSFL" and will not clear ...
  - a. Dual Microprocessor Controller (DMC) computer 1/8-Amp (Slo Blo) fuse is blown.
  - b. Failed Dual Microprocessor Controller (DMC) computer temperature sensor.
  - c. Broken wire and/or termination in sensor harness somewhere between the sensor bracket and the Dual Microprocessor Controller (DMC) computer.
  - d. Failed Dual Microprocessor Controller (DMC) computer.
2. L.E.D. display reads "dSFL" for a short period of time (30 seconds or less) and then returns to the normal stop "FILL" mode ...

**NOTE:** Once the Dual Microprocessor Controller (DMC) computer detects a problem, it updates every thirty (30) seconds so that if a problem was a loose connection in this circuit which corrected itself, the "dSFL" display condition would automatically be canceled.

- a. Loose wire and/or termination in sensor harness somewhere between the sensor bracket and the Dual Microprocessor Controller (DMC) computer.
- b. Failed Dual Microprocessor Controller (DMC) computer temperature sensor.

**J. DMC computer L.E.D. display reads "Hot"...**

The "Hot" display condition indicates a possible overheating condition. The Dual Microprocessor Controller (DMC) computer monitors the temperature in the dryer at all times. If the DMC computer detects that the temperature in the dryer has exceeded 170°F (77°C), it will disable **ALL** of the dryer outputs (shut the dryer down), the buzzer (tone) will sound for approximately 5 seconds, and the L.E.D. display will read "Hot" The L.E.D. display will continue to read "Hot" until the temperature has dropped to 170°F (77°C) or lower and the DMC computer is manually reset by closing and opening the Program Switch (PS).

Possible reasons for overheating...

1. Restriction in location exhaust duct work.
  - a. Dryer exhaust damper stuck in closed position.
  - b. Undersized exhaust duct work.
2. Insufficient make-up air.

**K. DMC computer L.E.D. display reads "SEFL"...**

The "SEFL" display condition indicates a rotational sensor circuit failure which means that there is a fault somewhere in the basket (tumbler) rotation detection circuit...or...the Dual Microprocessor Controller (DMC) computer program related to this circuit (PL01) is set incorrectly in the active mode ("SEn") where the dryer is not equipped with the optional rotation sensor and **should be set** in the non-active mode ("nSEn").

If the dryer is equipped with the optional rotational sensor and for whatever reason the Dual Microprocessor Controller (DMC) computer detects that the basket (tumbler) is not turning, it will disable **ALL** of the dryer outputs (shut the dryer down), and the L.E.D. display will read "SEFL". The L.E.D. display will continue to read "SEFL" until the Dual Microprocessor Controller (DMC) computer is manually reset by closing and opening the Program Switch (PS).

Possible causes...

1. Loose/slipping (out of proper adjustment) basket/tumbler belt.
2. Broken basket/tumbler belt.
3. Failed motor (refer to **Item B** on page 53 and page 54 and **Item E** on page 54).
4. Failure in the rotational sensor circuit ...
  - a. Failed rotational sensor.
  - b. Loose connection or break between the rotation sensor and the Dual Microprocessor Controller (DMC) computer.

**L. DMC computer will not accept any, or only accept certain keyboard (touchpad) entries...**

1. Failed keyboard (touchpad) label assembly.
2. Failed Dual Microprocessor Controller (DMC) computer.

**M. DMC computer locks up and the L.E.D. display reads erroneous message(s) or only partial segments...**

1. Transient power voltage (spikes)...disconnect power to the dryer, wait one (1) minute (***NOTE: for dryer models with the optional battery back up...disconnect battery***), then reestablish power to the dryer. If problem is still evident, proceed to **Items M2 thru M4**.
2. Failed keyboard (touchpad) label assembly.
3. Improper grounding of the dryer or the Dual Microprocessor Controller (DMC) computer ground connections to the panel or the dryer are not proper.
4. Failed Dual Microprocessor Controller (DMC) computer.

**N. Dryer stops during a cycle and the DMC computer L.E.D. display returns to "FILL" ...**

If the dryer is equipped with optional battery back up ...

1. Refer to **Item M1**, **Item M3**, or **Item M4** above.

If the dryer does not have optional battery back up ...

1. Loose connection somewhere in the power source to the dryer.
2. Loose connection in main power circuit to the Dual Microprocessor Controller (DMC) computer.
3. Improper grounding of the dryer or the Dual Microprocessor Controller (DMC) computer ground connections to the panel or the dryer are not proper.
4. Failed Dual Microprocessor Controller (DMC) computer.

**O. Heating unit is not operating (no heat)...basket (tumbler) is turning, DMC computer heat indicator dot is on but "HEAT" output L.E.D. is not...**

1. Failed Dual Microprocessor Controller (DMC) computer.

**P. Gas heating unit is not operating (no heat)...both DMC computer heat indicator dot and "HEAT" indicator are on...but no spark at burner area when the dryer is first started...**

1. Check motor/impellor (fan) drive belt.

2. Fault in sail switch circuit ...

a. Sail switch is out of adjustment or has failed.

b. Sail switch damper is not closing or is fluttering ...

1) Lint drawer/screen is dirty or clogged.

2) Restriction in exhaust duct work.

3. Fault in burner hi-limit circuit or thermostat.

4. Fault in basket (tumbler) hi-limit circuit or thermostat.

5. Failed Direct Spark Ignition (DSI) module (burner control).

6. Failed Direct Spark Ignition (DSI) ignitor and/or flame-probe assembly.

**Q. No heat (GAS MODELS ONLY)...ignitor sparks but there is no flame at burner...**

1. Direct Spark Ignition (DSI) ignitor probe out of adjustment.

a. Reposition ignitor assembly closer to the burner ribbon area. Also check to make sure ribbon in burner is flush all around the top of the burner tube (ribbon should not stick up at any area).

b. Check gap between ignitor assembly and the top of the burner. Gap **must be set** 1/8" +/- 1/32".

2. Failed ignitor flame-probe assembly or problem with wiring connections to the assembly.
3. **NO** gas (check shut off valves) or insufficient (low Water Column [W.C.] pressure) gas supply.
4. Failed Direct Spark Ignition (DSI) module.
5. Failed gas valve.

**R. No heat ...ignitor sparks, burner goes on and off right away...**

1. DSI flame sensor (probe) out of adjustment...reposition closer to the flame area.
2. Failed Direct Spark Ignition (DSI) flame sensor probe.
3. Sail switch is fluttering ...
  - a. Lint drawer/screen is dirty or clogged.
  - b. Restriction in exhaust duct work.
4. Insufficient make-up air.
5. Failed Direct Spark Ignition (DSI) module.

**S. Dryer operates, but is taking too long to dry...**

1. Exhaust duct work run is too long or is undersized...back pressure **cannot** exceed .3 inches Water Column (W.C.).
2. Low and/or inconsistent gas pressure.
3. Insufficient make-up air.
4. Poor air/ gas mixture at burner...yellow or poor flame pattern. Adjust gas burner air adjustment shutters.
5. Lint drawer/screen not being cleaned out on a regular basis or often enough.
6. Extractors (washers) not performing properly.

7. Sail switch is fluttering...restriction in exhaust.
8. Failed Dual Control Microprocessor (DMC) computer temperature sensor...temperature calibration is inaccurate.
9. Failed Dual Control Microprocessor (DMC) computer...temperature calibration is inaccurate.
10. Failed burner/oven hi-limit .
11. Failed basket (tumbler) hi-limit thermostat.
12. Lint accumulation in location exhaust system.

**T. Condensation on main door glass...**

1. Too long, undersized, or improperly installed duct work.
2. Exhaust back draft damper is stuck open or partially open.
3. Restriction in exhaust duct work.

**U. Dryer is making scraping noise at basket (tumbler) area...**

1. Check for object(s) caught in the basket (tumbler) wrapper area.
2. Basket (tumbler) is out of proper alignment ...
  - a. Check both the vertical alignment and lateral alignment.
  - b. Check gap between the front panel and the basket (tumbler) front...set screws may have come loose and basket (tumbler) walked forwards or backwards.

3. Loose or broken basket (tumbler) tie rod.
4. Broken basket (tumbler) support.

**V. Excessive noise and/or vibration...**

1. Dryer is not leveled properly.



2. Impellor (fan) out of balance or broken.
3. Loose basket (tumbler) tie rod.
4. Basket (tumbler) is out of adjustment, or adjustment bolts (hardware) are loose.
5. Loose motor or motor mount assembly.

**W. Basket (tumbler) turns too fast (as opposed to other baskets [tumblers])...**

1. Foreign object(s) caught between basket (tumbler) belt and motor shaft.

# SECTION IX

## DATA LABEL LOCATION/INFORMATION

### Data Label

Contact **American Dryer Corporation**

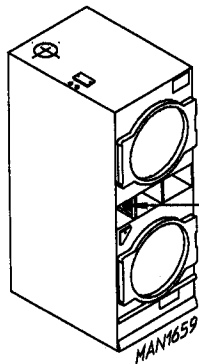

<b>MODEL</b> ADG630D	<b>SERIAL NO.</b> 345947 KD
<b>MANUFACTURING CODE NUMBER</b> 6305147130317010840X00000000000000 245,000 BTU MAX	
<b>TYPE OF HEAT</b> GAS/NATURAL	<b>HEAT INPUT</b> 122,500 BTUH PER POCKET
<b>ELECTRIC SERVICE</b> (2) 115V/60HZ/1PH 6 AMPS PER POCKET	
<b>GAS MANIFOLD PRESSURE</b> 3.5 IN WC	
<b>FOR USE WITH NATURAL AND L.P. GASES</b> 'NRTL' ANS Z215.2      b-1992      CLOTHES DRYER VOL II	
24 VOLT CONTROL VOLTAGE	

When contacting **American Dryer Corporation**, certain information is required to insure proper service/parts information from **ADC**. This information is on the data label that is located behind the middle access (control) door, on the right wall, adjacent to the gas valve train (as shown in the illustration above). When contacting **ADC** please have the **model number** and the **serial number** readily available.

## **THE DATA LABEL**

**1. MODEL NUMBER**

The model number is an **ADC** number which describes the size of the dryer and the type of heat (gas, electric, or steam).

**2. SERIAL NUMBER**

The serial number allows **ADC** to gather information on your particular dryer.

**3. MANUFACTURING CODE NUMBER**

The manufacturing code number is a number issued by **ADC** which describes **ALL** possible options on your particular model.

**4. TYPE OF HEAT**

The type of heat describes the type of heat; gas (either natural or Liquid Propane [L.P.]), electric, or steam.

**5. HEAT INPUT (for GAS DRYERS)**

This describes the heat input in British Thermal Units per Hour (BTUH).

**6. ELECTRIC SERVICE**

This describes the electric service for your particular model.

**7. GAS MANIFOLD PRESSURE (for GAS DRYERS)**

This describes the manifold pressure taken at the gas valve tap.

ADC 112131 1--06/09/93-15 2-07/27/93-15  
3\*-02/18/94-250

