

LEGEND LÉGENDE

- COMPONENT MAY OR MAY NOT BE USED
COMPOSANT (USAGE FACULTATIF)
- TIMER CONSTRUCTION
CONSTRUCTION DE LA MINUTERIE
- TERMINAL CONNECTION
RACCORD AUX BORNES
- SPLICE
EPISSURE
- IN LINE CONNECTION
CONNEXION EN LIGNE

TIMER POSITION POSITION DE LA MINUTERIE	TIMER SWITCH					
	TM-OR	TM-WB	BK-BU-V	BK-BU	BK-R	T-W
AUTO-REGULAR RÉGULIÈRE						
AUTO-SOFT/LOW HEAT CHALEUR AUTO-DOUCE/BASSE						
COOL DOWN/ATR DE REFROIDISSEMENT/AIR	○	○	■	■	■	■
END OF CYCLE FIN DE PROGRAMME						
TIMED-REGULAR MINUTE-RÉGULIÈRE						
TIMED-SOFT/LOW HEAT MINUTÉE DOUCE/FAIBLE CHALEUR						
GUARD GARDE						+

LEGEND LÉGENDE

- = OPEN OUVERTE
- ▨ = CLOSED FERMÉE
- = DOESN'T MATTER
PEU IMPORTE
- = EITHER (NOT BOTH)
L'UN OU L'AUTRE
- ⊕ = CLOSED INTERMITTENTLY
FERMETURE INTERMITTENTE

MANUFACTURED UNDER ONE OR MORE OF THE FOLLOWING CANADIAN PATENTS.
FABRIQUÉ CONFORMEMENT A UN OU PLUSIEURS DES BREVETS CANADIENS CI DESSOUS.
0950070 0958795 1095151 1176841
0950072 1026093 1173132
CAUTION: LABEL ALL WIRES PRIOR TO DISCONNECTION WHEN SERVICING CONTROLS. WIRING ERRORS CAN CAUSE IMPROPER AND DANGEROUS OPERATION. VERIFY PROPER OPERATION AFTER SERVICING.
MISE EN GARDE: IDENTIFIER PAR INSCRIPTION SUR ÉTIQUETTE TOUS LES FILS AVANT LA DÉCONNEXION LORS DE L'ENTRETIEN OU RÉPARATION DES COMMANDES. DES ERREURS DE FILERIE PEUVENT CAUSER UN FONCTIONNEMENT INAPPROPRIÉ ET DANGEREUX. VÉRIFIER LE FONCTIONNEMENT CORRECT APRES L'EXECUTION DE L'ENTRETIEN OU RÉPARATION.

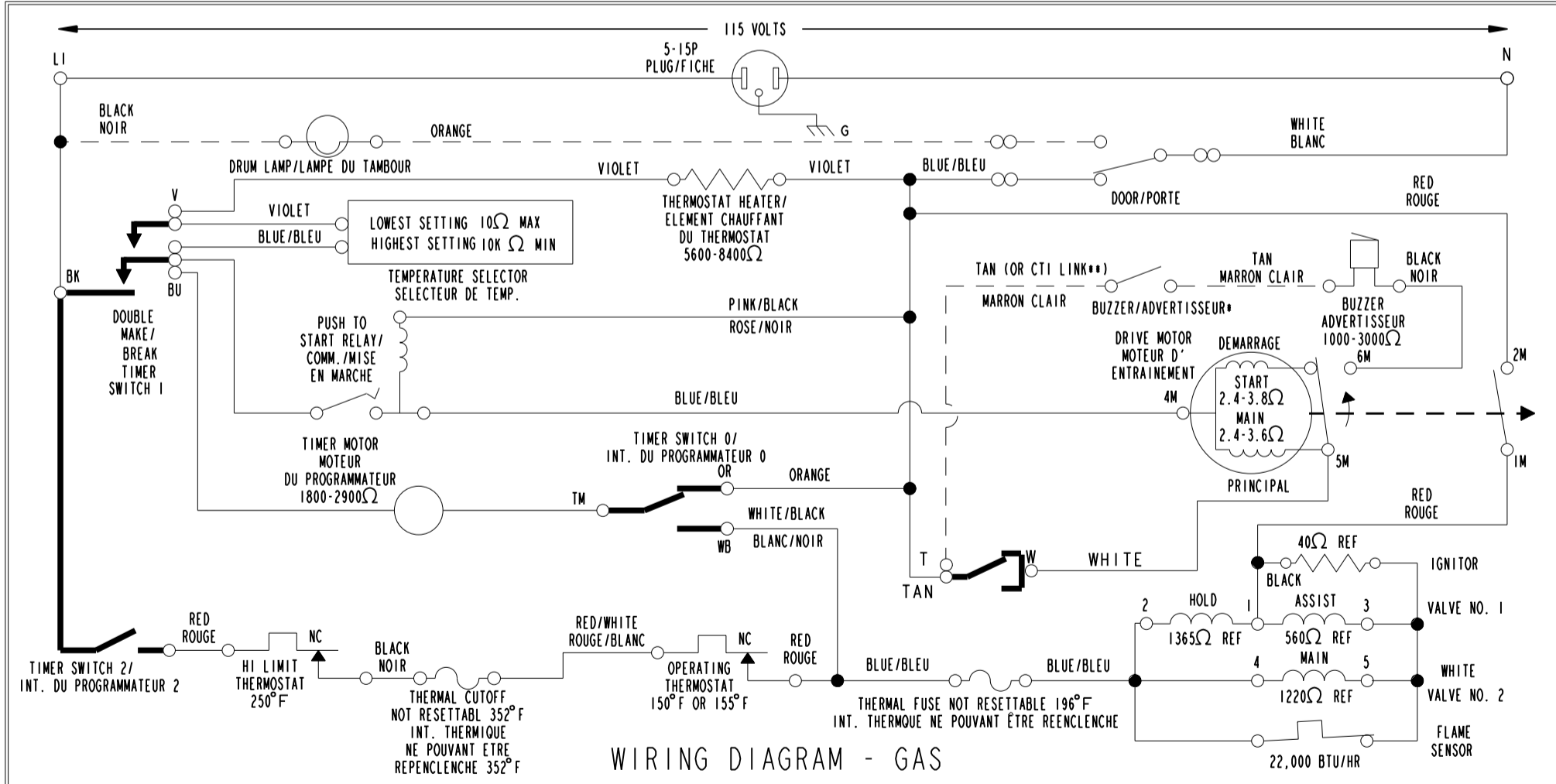
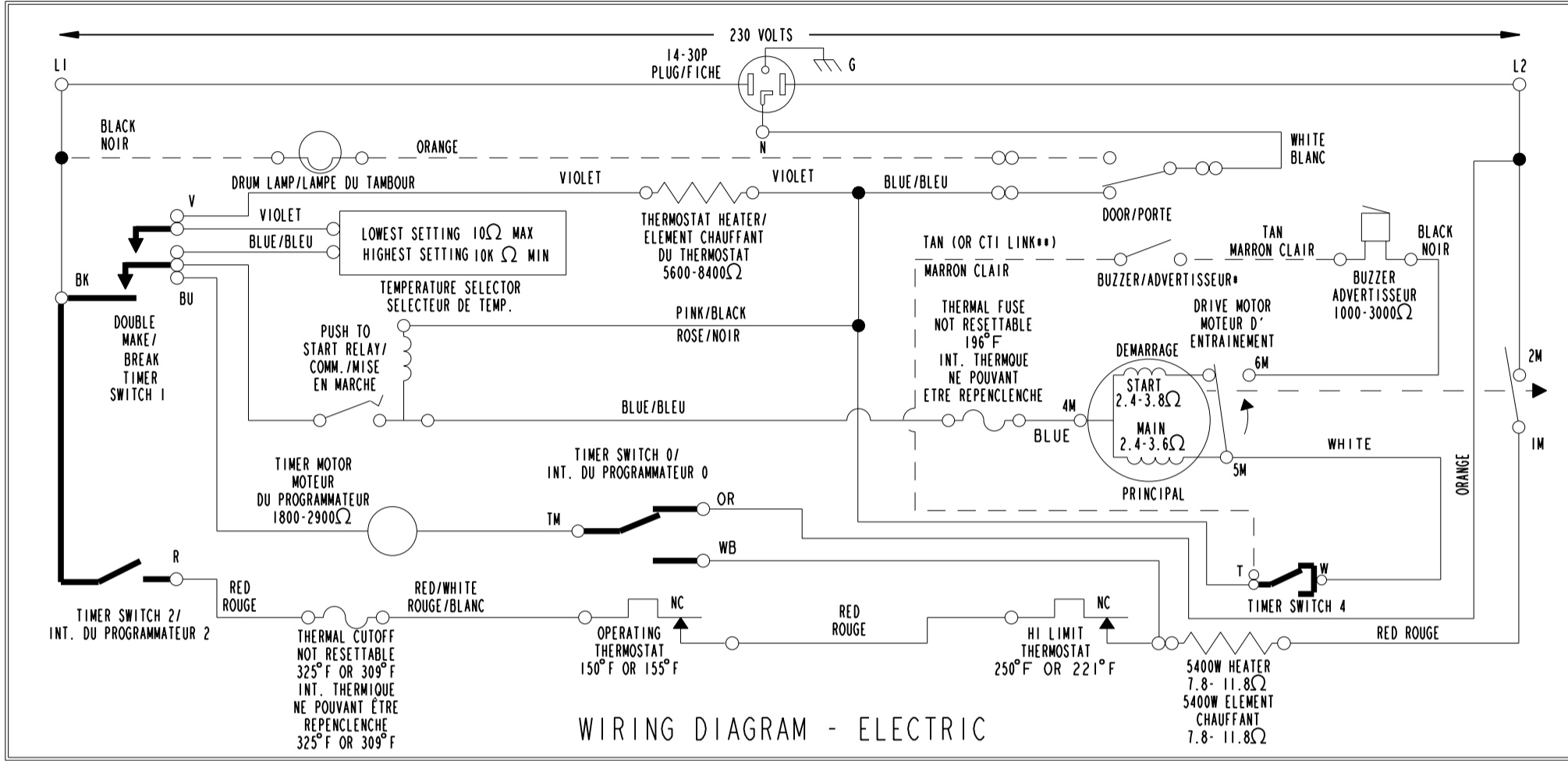

- ### LEGEND LÉGENDE
- BLUE = BLEU
 - BLACK = NOIR
 - RED = ROUGE
 - WHITE = BLANC
 - TAN = MARRON CLAIR
 - PINK = ROSE
 - YELLOW = JAUNE
 - GREEN = VERT

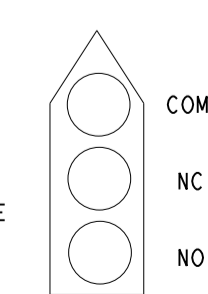
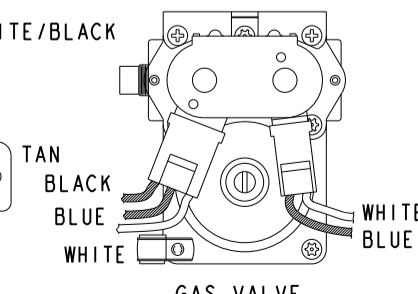
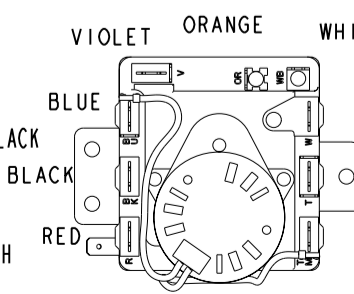
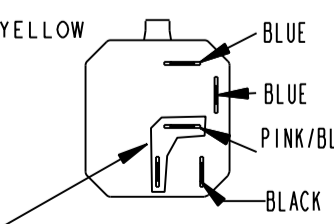
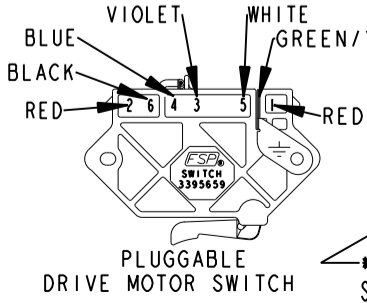

**TAN WIRE MAY BE REPLACED WITH STAKE FROM PINK/BLACK TERMINAL ON PUSH-TO-START RELAY

* SWITCH MAY BE REPLACED WITH JUMPER
Le contacteur peut être remplacé par un fil de connexion

PART NO.
3979704
REV REL