

**Amana LE4207W (BOM: P1178402W W) 11 - MTR CONN BLOCK/TERM & EXTRACTOR TOOL**

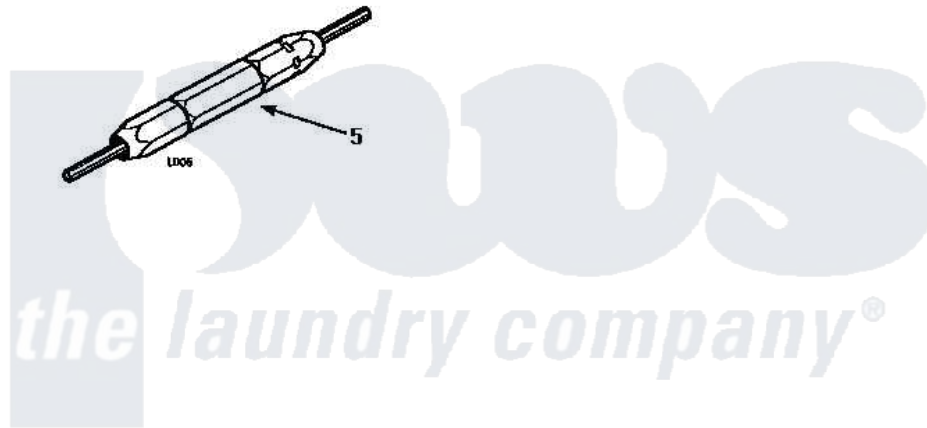
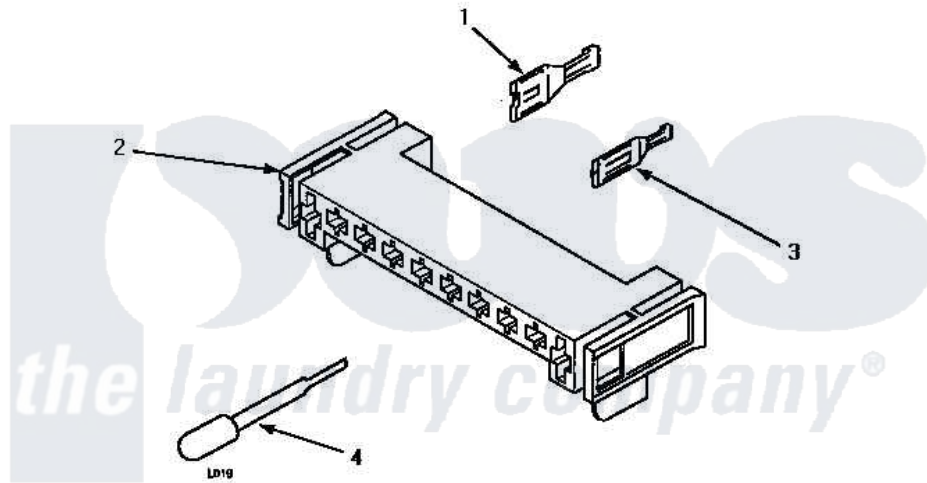

**MOTOR CONNECTION BLOCK, TERMINALS AND TERMINAL EXTRACTOR TOOLS**

Amana Residential Amana LE4207W (BOM: P1178402W W) [Dryer Parts](#) Parts Diagram 11 - MTR CONN BLOCK/TERM & EXTRACTOR TOOL

[Click on the part number to view part](#)

Item	Original Part Number	Replaced By	Status	Part Description
1	00255		Not Available	(1/4 INCH-FOR (1) 12 GAUGE WIR
"	<a href="#">Y00256</a>			Spade Terminal Or
2	<a href="#">500338</a>			Housing-10 Position
3	<a href="#">Y00188</a>			Molex Terminal
4	<a href="#">283P4</a>			Terminal Extractor Tool
5	<a href="#">190P4</a>			Terminal Extractor Tool